

WELCOME
To a Regular Meeting of the
Coeur d'Alene City Council
Held in the Library Community Room

AGENDA
VISION STATEMENT

Our vision of Coeur d'Alene is of a beautiful, safe city that promotes a high quality of life and sound economy through excellence in government.

The purpose of the Agenda is to assist the Council and interested citizens in the conduct of the public meeting. Careful review of the Agenda is encouraged. Testimony from the public will be solicited for any item or issue listed under the category of Public Hearings. Any individual who wishes to address the Council on any other subject should plan to speak when **Item E - Public Comments** is identified by the Mayor. The Mayor and Council will not normally allow audience participation at any other time.

January 21, 2020, 6:00 p.m.

A. CALL TO ORDER/ROLL CALL

B. INVOCATION: Pastor Wayne Foil, Hayden Bible Fellowship

C. PLEDGE OF ALLEGIANCE:

D. AMENDMENTS TO THE AGENDA: Any items added less than forty-eight (48) hours prior to the meeting are added by Council motion at this time.

E. PUBLIC COMMENTS: (Each speaker will be allowed a maximum of 3 minutes to address the City Council on matters that relate to City government business. Please be advised that the City Council can only take official action this evening for those items listed on the agenda.)

*****ITEMS BELOW ARE CONSIDERED TO BE ACTION ITEMS**

F. ANNOUNCEMENTS:

- 1. City Council**
- 2. Mayor – Appointments:** Michael Pereira to the Design Review Commission, and James Chapkis and Patrick Murray to the Parking Commission

G. CONSENT CALENDAR: Being considered routine by the City Council, these items will be enacted by one motion unless requested by a Councilmember that one or more items be removed for later discussion.

1. Approval of Council Minutes for the January 7, 2020 Council Meeting.

2. Approval of Bills as Submitted.
3. Approval of Financial Report.
4. Setting of General Services/Public Works Committee meeting for Monday, January 27, 2020 at 12:00 noon.
5. Setting of a Public Hearing for CDBG Annual Action Plan 2020 for February 4, 2020
As Recommended by the Community Planning Director
6. Approval of SS-19-14, Bunker Park: Final Plat
As Recommended by the City Engineer
7. **Resolution No. 20-005 -**
 - a. Approval S-3-16.m. - Bolivar 4th Addition: Improvements, Maintenance/Warranty Agreement and Security
As Recommended by the City Engineer
 - b. Approval of a utility water line easement at 1681 W. Pampas Lane
As Recommended by the Water Superintendent

H. OTHER BUSINESS:

1. **Resolution No. 20-006 -** Approval of a License Agreement with Cellco Partnership d/b/a Verizon Wireless for use of city property in connection with the operation of a wireless network.

Staff Report by: Mike Gridley, City Attorney

I. PUBLIC HEARING:

1. V-19-03; Vacation of a portion of Seltice Way right-of-way adjoining the southerly boundary of Tax # 8882, Tax # 10490, & Tax # 22364 in the City of Coeur d'Alene.

Staff Report by: Dennis Grant, Engineering Project Manager

- a. **Council Bill No. 20-1000 -** Approving the of Seltice Way right-of-way adjoining the southerly boundary of Tax # 8882, Tax # 10490, & Tax # 22364 in the City of Coeur d'Alene

J. ADJOURNMENT

*This meeting is aired live on CDA TV Spectrum Cable Channel 1301
and on Facebook live through the City's Facebook page.*

Coeur d'Alene

CITY COUNCIL MEETING

January 21, 2020

MEMBERS OF THE CITY COUNCIL:

Steve Widmyer, Mayor

Council Members McEvers, English, Evans, Gookin, Miller, Wood

ANNOUNCEMENTS

Memo to Council

DATE: January 13, 2020

RE: Appointments to Boards/Commissions/Committees

The following reappointment is presented for your consideration for the January 21st Council Meeting:

MICHAEL PEREIRA

Design Review Commission

A copy of the data sheet has been placed by your mailboxes.

Sincerely,

Amy Ferguson
Executive Assistant

cc: Renata McLeod, Municipal Services Director
Shana Stuhlmiller

Memo to Council

DATE: January 16, 2020

RE: Appointments to Boards/Commissions/Committees

The following reappointments are presented for your consideration for the January 21st Council Meeting:

PATRICK MURRAY	Parking Commission
JAMES CHAPKIS	Parking Commission

Copies of the data sheets have been placed by your mailboxes.

Sincerely,

Amy Ferguson
Executive Assistant

cc: Renata McLeod, Municipal Services Director

CONSENT CALENDAR

MINUTES OF A REGULAR MEETING OF THE CITY
COUNCIL OF THE CITY OF COEUR D'ALENE, IDAHO,
HELD AT THE LIBRARY COMMUNITY ROOM

January 7, 2020

The Mayor and Council of the City of Coeur d'Alene met in a regular session of said Council at the Coeur d'Alene City Library Community Room January 7, 2020 at 6:00 p.m., there being present upon roll call the following members:

Steve Widmyer, Mayor

Dan Gookin) Members of Council Present
Kiki Miller)
Dan English)
Woody McEvers)
Amy Evans)
Loren Ron Edinger) Member of Council Absent

CALL TO ORDER: Mayor Widmyer called the meeting to order.

INVOCATION: Pastor Ray Duran with Candlelight Church provided the invocation.

PLEDGE OF ALLEGIANCE: Councilmember McEvers led the pledge of allegiance.

AMENDMENTS TO THE AGENDA: Motion by Gookin, seconded by McEvers to add item no. 5 to Agenda Item F, Consent Calendar: Approval of Final Plat for SS-19-13, Georgia Addition to Cd'A; to the agenda. A timely request was made to include this item on the agenda, but it was inadvertently omitted when the agenda was prepared, and the Final Plat must be approved before building permits can be issued. **Motion carried.**

CONSENT CALENDAR: **Motion** by McEvers, second by Gookin, to approve the consent calendar.

1. Approval of Council Minutes for December 17, 2019.
2. Approval of Bills as Submitted.
3. Setting of General Services and Public Works Committees meetings for January 13, 2020 at 12:00 noon and 4:00 p.m. respectively.
4. **Resolution No. 20-001** - A RESOLUTION OF THE CITY OF COEUR D'ALENE, KOOTENAI COUNTY, IDAHO, AUTHORIZING THE FOLLOWING ACTIONS OF THE CITY OF COEUR D'ALENE: DECLARATION AS SURPLUS A 2008 CHEVROLET TAHOE FROM THE POLICE DEPARTMENT AND AUTHORIZATION THE SALE OF THE SURPLUS PROPERTY AT AUCTION; THE PURCHASE OF A 500 KW CATERPILLAR GENERATOR IN THE AMOUNT OF \$75,975.00 FROM WESTERN STATES CAT FOR THE LINDEN WELL FOR THE WATER DEPARTMENT AND APPROVAL OF THE PURCHASE OF A CONTROL SYSTEM IN THE AMOUNT OF NINETY-SIX THOUSAND FOUR HUNDRED AND

NO/100 DOLLARS (\$96,400.00) FROM SPHCONTROLS FOR THE POLICE DEPARTMENT.

ROLL CALL: Gookin Aye; Evans Aye; English Aye; Miller Aye; McEvers Aye. **Motion Carried.**

MAYOR AND COUNCIL COMMENTS:

Councilmember Miller noted that there is a position on Library Board of Trustees currently open. Any interested parties should apply through www.cdavid.org/volunteer.

Councilmember Gookin acknowledged the students present, noting that the meeting should be worth their time. He also commented that city employee Michelle Cushing, who was the CDBG Grant Administrator, is leaving City employment and thanked Michelle for her work in getting information out to the community. He said that she will be missed.

Mayor Widmyer asked for confirmation of the appointment of Ben Wolfinger to the Civil Service Commission and Ali Shute to the Arts Commission.

MOTION: Motion by Evans, seconded by McEvers to appoint Ben Wolfinger to the Civil Service Commission and Ali Shute to the Arts Commission. **Motion carried.**

Mayor Widmyer expressed his thanks for the dedicated service given by Councilmember Edinger and noted that Governor Brad Little provided him with a commendation in appreciation of his fifty years of service. Additionally, Mr. Edinger asked the Mayor to read a note to the community into the record in his absence.

To the citizens of Coeur d'Alene, I regret that I can't be here tonight to see the installation of three fine people, Dan English, Dan Gookin, and the installation of our newly elected Councilperson Christie Wood. You are in good hands. They will look out for you Coeur d'Alene. Thank you to our city employees for their tireless efforts to better our City. I have been lucky to have served with many outstanding Councils. Thank you for giving me the privilege of being your Mayor and Councilman for these many years. It has been an HONOR. God bless all of you. Ron Edinger

OATHS OF OFFICE: City Clerk Renata McLeod administered the oath of office to re-elected Councilmembers Dan Gookin, and Dan English, and newly elected Councilmember Christie Wood.

RECESS: Mayor Widmyer called for a recess at 6:09 p.m. The meeting reconvened at 6:13 p.m.

ROLL CALL: Mayor Widmyer asked for a roll call of the new Council with members present being:

Woody McEvers) Members of Council Present
Amy Evans)
Dan English)
Kiki Miller)
Dan Gookin)
Christie Wood)

ELECTION OF COUNCIL PRESIDENT: **Motion** by Evans, seconded by Gookin to elect Councilmember McEvers as Council President. **Motion carried.**

COMMITTEE APPOINTMENTS: Mayor Widmyer noted that staff is proposing one Council sub-committee per month that would meet twice, called the “General Services/Public Works Committee.” The first grouping of Council will attend the first meeting of the month and will include Amy Evans as Chairman, Christie Wood, and Dan English. The attendees of the second meeting of the month will include Woody McEvers as Chairman, Dan Gookin, and Kiki Miller.

The other committee assignments are as follows:

- Councilmember Wood: Tubbs Hill Foundation liaison; Parks Foundation liaison; Sick Leave Bank; Parks and Recreation Commission
- Councilmember Evans: Arts Commission; Ped/Bike Committee; City Legislative Committee; CDA2030
- Councilmember Gookin: KMPO
- Councilmember McEvers: CDA TV; EMS; and Lake City Center Liaison
- Councilman English: Parking Commission; ignite CDA
- Councilman Miller: Library Board; and the Historic Preservation Commission

The Mayor will continue to serve as the City’s representative to Jobs Plus (CDA Area Economic Development Corporation), Ignite CDA, and the Governor’s Workforce Development Council.

RESOLUTION NO. 20-002

A RESOLUTION OF THE CITY OF COEUR D’ALENE, KOOTENAI COUNTY, IDAHO, AUTHORIZING STAFF TO APPLY FOR A WATERFRONT IMPROVEMENT FUND MATCHING GRANT TO PURCHASE NEW BOAT DOCKS AND PILINGS AT THE 3RD STREET BOAT LAUNCH, AND ACCEPTANCE OF GRANT FUNDS UPON AWARD.

STAFF REPORT: Trails Coordinator Monte McCully explained the current conditions of the 3rd Street dock and their need for replacement and requested authority to apply for a grant to aid in the cost of the dock enhancements. He noted that this year was a great year to apply due to the lack of other large projects being requested for funding. He further explained that the grant would provide an opportunity to replace the docks to match the condition of the other city docks near the Harbor House. The grant request will be \$145,891, with a city match of \$21,884 which would be funded through the city’s waterfront improvement fund.

DISCUSSION: Councilmember Miller noted that she had talked to the City Administrator and expressed concern about how the grant request came forward; however, she indicated that she will support the grant opportunity. She noted that there was no mention of the docks remodel within the capital plan and believes there were a couple of items that should have been included. Councilmember Wood noted that the Parks and Recreation Commission was in favor of fixing the docks, as they are in disarray, and this is an opportunity to use grant dollars for the needed improvements and she commented that she hoped the grant gets approved.

MOTION: Motion by English, seconded by Gookin to approve **Resolution No. 19-002;** authorizing staff to proceed with applying for a Waterfront Improvement Fund grant to purchase new boat docks and pilings at the 3rd Street Boat Launch, and acceptance upon award.

ROLL CALL: Evans Aye; Miller Aye; McEvers Aye; Gookin Aye; English Aye; Wood Aye.
Motion carried.

RESOLUTION NO. 20-003

A RESOLUTION OF THE CITY OF COEUR D'ALENE, KOOTENAI COUNTY, IDAHO, AUTHORIZING A CONTRACT WITH T-O ENGINEERS, INC., FOR DESIGN OF THE FUTURE WILBUR AVENUE/RAMSEY ROAD TRAFFIC SIGNAL.

STAFF REPORT: City Engineer Chris Bosley explained that Greenstone Homes is preparing to begin development of another phase of Coeur d'Alene Place. This phase will construct the intersection of Wilbur Avenue with Ramsey Road. A subsequent phase will extend Wilbur Avenue to Moselle Drive, facilitating traffic movements in and out of the large residential area. Once that connection is made, a traffic signal will be needed at Ramsey Road and Wilbur Avenue. Greenstone Homes would like to have the underground work complete in coordination with their next phase to eliminate the need to tear out new construction when the signal is warranted during another phase. T-O Engineers is on the City's on-call roster for engineering services and can complete the traffic signal design and the funding would come from impact fees. He requested approval to design the signal so that the underground development for the future signal will be able to be installed now.

DISCUSSION: Councilmember McEvers asked when the developer would be required to pay for items such as the traffic signal. Mr. Bosley noted that has not been agreed upon at this stage of development; however, Greenstone Homes did pay for a traffic study, which confirmed the future need of the signal, but no fees are currently earmarked for the signal. However, Coeur d'Alene Place has paid into the impact fee fund with their development over the years. Councilmember Gookin said that in a 2018 article from the Press it was noted that the developer was going to pay for the engineering of the signal, and wondered what changed since that time. Mr. Bosley said that it was an original condition of development and once they discussed the expense with their attorney, it was clarified how much was paid in impact fees in the past and the expected future payments into the fund. Additionally, they discussed how much traffic the development would contribute and the settlement was to pay this portion out of existing impact fees. Councilmember Gookin noted that the impact fee report is 16 years out of date, while other

fees are updated annually, and the city is lagging on impact fees. He noted that the Quadrant 1 traffic study is outdated and that the last year's capital improvement project budget did not include the signal and he feels the developer should pay for the signal. Mr. Bosley reiterated that at this time the City has not established who will pay for the signal, and the request is to get the design work complete to be able to install underground items during the current development stage. Councilmember English noted that he agrees the impact fees need to be updated and he can picture the impact down the road and that it makes more sense to do the early stuff now. Councilmember Wood asked if impact fees updates are in the works. Mayor Widmyer noted that a study is in the queue; however, it would affect affordability of housing, but should be updated. Mr. Tymesen explained that staff looked at impact fees through the "Great Recession" and confirmed that staff is in the process of updating the comprehensive plan which will establish densities and will go hand-in-hand with an impact fee update. In the older version of the impact fee plan they would not have planned for the Wilbur signal, but it will be added to the new plan.

MOTION: Motion by English, seconded by Evans to approve **Resolution No. 19-003;** Approval of a Contract with T-O Engineers for design of the future Wilbur Avenue/Ramsey Road traffic signal.

ROLL CALL: Miller Aye; McEvers Aye; Gookin No; English Aye; Wood Aye; Evans Aye.
Motion carried.

AUTHORIZATION OF STAFF TO PROCEED WITH APPLYING FOR A LOCAL HIGHWAY SAFETY IMPROVEMENT PROGRAM (LHSIP) GRANT FOR PEDESTRIAN SAFETY IMPROVEMENTS.

Staff Report: Mr. Bosley explained that a Federal grant opportunity has become available, administered by the Local Highway Technical Assistance Council (LHTAC) to provide safety improvements. This same grant was awarded to the City in 2018 for traffic signal upgrades on Sherman Avenue and Lakeside Avenue. Those improvements will occur in fiscal year 2021. This fiscal year 2022 grant application, which is due on January 16th, would fund pedestrian safety improvements and ADA compliance at several needed locations throughout the City. The City's estimated match requirement for the LHSIP grant is \$37,801 (7.34%). Though not currently budgeted for, if awarded the grant the funding would need to be included in the FY 2022 budget. The resulting project would provide approximately \$515,000 in pedestrian safety improvements in Coeur d'Alene. The project would include additional rapid flashing beacons (RFB's). One of the requirements of the grant application is to prove a reduction in fatal or pedestrian injury accidents, which he is certain the city can provide based on statistics over the past year. He reviewed several possible locations throughout the community.

DISCUSSION: Councilmember McEvers asked if drivers are supposed to stop when the flashing beacons are activated. Mr. Bosley noted the code requires vehicles to yield; however, they should stop if there are pedestrians in the crossing. Councilmember McEvers noted that the City has provided a lot of attention to the 5th Street and Sherman Avenue beacon and wondered if the beacons were going to be high maintenance. Mr. Bosley noted that the 5th Street and Sherman Avenue signal is the highest-use beacon. There were some bugs and the battery wore

out and he hopes the technology gets better over time. Councilmember Wood suggested that the Engineering Division work with the Police Department on those types of grants in the future as they can provide additional resources.

MOTION: Motion by Evans, seconded by Miller to authorize staff to proceed with applying for a Local Highway Safety Improvement Program (LHSIP) grant for pedestrian safety improvements. **Motion carried.**

RESOLUTION NO. 20-004

A RESOLUTION OF THE CITY OF COEUR D'ALENE, KOOTENAI COUNTY, IDAHO, APPROVING A CONTRACT WITH J.U.B. ENGINEERS, INC., FOR PRELIMINARY BUDGET EVALUATION FOR THE FUTURE ATLAS ROAD IMPROVEMENT PROJECT.

STAFF REPORT: Mr. Bosley noted that he is requesting approval to award a preliminary budget evaluation contract to J-U-B Engineers for future Atlas Road improvements. Much of Atlas Road remains as a rural road and has not been updated to an urban street design per City standards. The street requires much maintenance in terms of regular patching and pothole filling, particularly south of Hanley Avenue. The City's desire is to reconstruct Atlas Road into a 3-lane urban section, complete with curb, gutter, and stormwater swales. KMPO is currently requesting applications for funding transportation projects. More points are awarded to projects that are further along in design. By contracting J-U-B for \$15,000 to complete the preliminary budget evaluation, additional points would be awarded toward the project as well as giving the City a more accurate depiction of costs and impacts, particularly right-of-way and utility. Mr. Bosley noted that this would be an advantage at applying for funding through KMPO. J-U-B Engineers is on the City's on-call roster for engineering services and could complete the preliminary budget evaluation and funding would come from impact fees.

DISCUSSION: Mayor Widmyer asked for clarification regarding how far to the north the references to turning Atlas Road into an urban roadway would go. Mr. Bosley explained that it would eventually go to Prairie Avenue; however, this project would just go to Hanley Avenue. He noted that from Hanley to Prairie Avenues, curb and gutters exist and the road is in better shape than to the south. Mayor Widmyer asked what the County was planning for the future of Huetter road. Mr. Bosley noted that the future of Huetter Road would include turning it into a frontage road with the bypass running parallel to the current road, and with Hanley Avenue being the first point to connect into the bypass. Councilmember McEvers said that he felt that completing the study would allow for funding later and wondered if there would be an opportunity to talk to the Forest Service about the need for modified swale plans, like what was done in the Government Way project. Mr. Bosley said he would be willing to talk to the Forest Service about that opportunity. Councilmember Gookin asked if the plan would include mitigation of the cut-through traffic at Master and Atlas Avenues. Mr. Bosley said that it would be a discussion point for all intersections.

MOTION: Motion by Gookin, seconded by Miller to approve **Resolution No. 20-004**; Approving a Contract with J.U.B. Engineering for preliminary budget evaluation for the future Atlas Road improvement project.

ROLL CALL: McEvers Aye; Gookin Aye; English Aye; Wood Aye; Evans Aye; Miller Aye.
Motion carried.

ADJOURN Motion by McEvers, seconded by Miller that there being no other business this meeting be adjourned. **Motion carried.**

The meeting adjourned at 6:53 p.m.

ATTEST:

Steve Widmyer, Mayor

Renata McLeod, CMC
City Clerk

RECEIVED

JAN - 7 2020

CITY CLERK

CITY OF COEUR D'ALENE
Treasurer's Report of Cash and Investment Transactions

FUND	BALANCE 11/30/2019	RECEIPTS	DISBURSE- MENTS	BALANCE 12/31/2019
<u>General-Designated</u>	\$1,624,134	\$22,141	\$15,698	\$1,630,577
<u>General-Undesignated</u>	8,420,405	7,202,941	11,624,956	3,998,390
<u>Special Revenue:</u>				
Library	(50,855)	47,712	152,444	(155,587)
CDBG	(33,234)	33,423	6,495	(6,306)
Cemetery	102,999	31,029	22,986	111,042
Parks Capital Improvements	1,778,925	5,319	212,655	1,571,589
Impact Fees	3,670,034	127,812		3,797,846
Annexation Fees	94,290	149		94,439
Cemetery P/C	1,418,978	15,157	40,013	1,394,122
Jewett House	33,497	53	508	33,042
Reforestation	25,603	990		26,593
Street Trees	202,999	6,920		209,919
Community Canopy	3,067	365	40	3,392
Public Art Fund	92,728	7,437	8,000	92,165
Public Art Fund - ignite	505,992	822	7,100	499,714
Public Art Fund - Maintenance	133,944	210		134,154
<u>Debt Service:</u>				
2015 G.O. Bonds	85,992	21,310		107,302
<u>Capital Projects:</u>				
Street Projects	1,387,412	2,184	587	1,389,009
Atlas Waterfront Project	-			-
<u>Enterprise:</u>				
Street Lights	93,295	95,723	57,415	131,603
Water	3,267,446	1,053,620	919,964	3,401,102
Water Capitalization Fees	7,872,857	137,347	642,823	7,367,381
Wastewater	9,213,611	1,053,980	910,838	9,356,753
Wastewater - Equip Reserve	1,090,212	27,500		1,117,712
Wastewater - Capital Reserve	1,500,000			1,500,000
WWTP Capitalization Fees	2,069,068	327,930	3,305	2,393,693
WW Property Mgmt	60,668			60,668
Sanitation	1,566,906	398,673	337,942	1,627,637
Public Parking	281,824	37,638	75,545	243,917
Drainage	1,028,277	96,905	84,601	1,040,581
Wastewater Debt Service	1,069,485	1,683		1,071,168
<u>Fiduciary Funds:</u>				
Kootenai County Solid Waste Billing	235,633	250,434	235,744	250,323
Police Retirement	933,767	14,605	41,503	906,869
Sales Tax	1,554	2,110	1,554	2,110
BID	253,597	8,430		262,027
Homeless Trust Fund	350	767	350	767
GRAND TOTAL	\$50,035,460	\$11,033,319	\$15,403,066	\$45,665,713

I HEREBY SWEAR UNDER OATH THAT THE AMOUNTS REPORTED ABOVE, ON THE CASH BASIS ARE TRUE AND CORRECT TO THE BEST OF MY KNOWLEDGE.



Vonnice Jensen, Comptroller, City of Coeur d'Alene, Idaho

CITY OF COEUR D'ALENE
 BUDGET STATUS REPORT
 THREE MONTHS ENDED
 December 31, 2019

RECEIVED

JAN - 7 2020

CITY CLERK

FUND OR DEPARTMENT	TYPE OF EXPENDITURE	TOTAL BUDGETED	SPENT THRU 12/31/2019	PERCENT EXPENDED
Mayor/Council	Personnel Services	\$254,425	\$56,421	22%
	Services/Supplies	11,400	(94)	-1%
Administration	Personnel Services	209,521	52,731	25%
	Services/Supplies	7,200	365	5%
Finance	Personnel Services	679,466	160,611	24%
	Services/Supplies	518,050	230,892	45%
Municipal Services	Personnel Services	1,273,999	327,258	26%
	Services/Supplies	546,375	250,426	46%
	Capital Outlay			
Human Resources	Personnel Services	328,696	82,548	25%
	Services/Supplies	71,823	24,812	35%
Legal	Personnel Services	1,240,704	325,485	26%
	Services/Supplies	51,153	21,111	41%
Planning	Personnel Services	675,488	154,663	23%
	Services/Supplies	297,800	30,896	10%
	Capital Outlay			
Building Maintenance	Personnel Services	383,106	80,763	21%
	Services/Supplies	172,875	40,225	23%
	Capital Outlay	120,000		
Police	Personnel Services	14,216,783	3,684,438	26%
	Services/Supplies	1,617,216	281,092	17%
	Capital Outlay	140,161	4,487	3%
Fire	Personnel Services	9,911,402	2,813,251	28%
	Services/Supplies	641,095	100,281	16%
	Capital Outlay	23,000	22,224	97%
General Government	Services/Supplies	125,750	1,525,221	1213%
	Capital Outlay		302,998	
Police Grants	Personnel Services		16,584	
	Services/Supplies			
	Capital Outlay			
CdA Drug Task Force	Services/Supplies			
	Capital Outlay			
Streets	Personnel Services	3,086,704	763,848	25%
	Services/Supplies	1,797,404	196,371	11%
	Capital Outlay	155,000	7,881	5%
Parks	Personnel Services	1,684,388	350,191	21%
	Services/Supplies	687,150	107,490	16%
	Capital Outlay	126,000	21,000	17%

CITY OF COEUR D'ALENE
BUDGET STATUS REPORT
THREE MONTHS ENDED
December 31, 2019

FUND OR DEPARTMENT	TYPE OF EXPENDITURE	TOTAL BUDGETED	SPENT THRU 12/31/2019	PERCENT EXPENDED
Recreation	Personnel Services	556,208	140,517	25%
	Services/Supplies	196,280	24,319	12%
	Capital Outlay	9,500		
Building Inspection	Personnel Services	898,321	213,766	24%
	Services/Supplies	41,256	4,430	11%
	Capital Outlay	24,233	(1,248)	-5%
Total General Fund		<u>42,779,932</u>	<u>12,418,258</u>	<u>29%</u>
Library	Personnel Services	1,353,266	333,121	25%
	Services/Supplies	252,500	63,614	25%
	Capital Outlay	180,000	38,779	22%
CDBG	Services/Supplies	597,467	39,786	7%
Cemetery	Personnel Services	190,877	39,934	21%
	Services/Supplies	105,950	20,759	20%
	Capital Outlay	72,800	18,950	26%
Impact Fees	Services/Supplies	360,000		
Annexation Fees	Services/Supplies	99,000	99,000	100%
Parks Capital Improvements	Capital Outlay	564,500	501,719	89%
Cemetery Perpetual Care	Services/Supplies	191,500	50,376	26%
Jewett House	Services/Supplies	28,853	1,626	6%
Reforestation	Services/Supplies	5,000		
Street Trees	Services/Supplies	104,000	1,840	2%
Community Canopy	Services/Supplies	2,000		
Public Art Fund	Services/Supplies	369,300	26,411	7%
		<u>4,477,013</u>	<u>1,235,916</u>	<u>28%</u>
Debt Service Fund		<u>878,932</u>		

CITY OF COEUR D'ALENE
BUDGET STATUS REPORT
THREE MONTHS ENDED
December 31, 2019

FUND OR DEPARTMENT	TYPE OF EXPENDITURE	TOTAL BUDGETED	SPENT THRU 12/31/2019	PERCENT EXPENDED
Seltice Way	Capital Outlay		275	
Seltice Way Sidewalks	Capital Outlay	63,986		
Traffic Calming	Capital Outlay	8,472		
Kathleen Avenue Widening	Capital Outlay	445,000		
US 95 Upgrade	Capital Outlay	226,839		
15th Street	Capital Outlay	53,015		
Industrial Park Loop & Atlas	Capital Outlay	804,500	22,002	3%
Downtown Signal Imprvmnts	Capital Outlay	10,000	20,618	206%
Atlas Waterfront Project	Capital Outlay			
NW Blvd Traffic Signals	Capital Outlay		587	
		1,611,812	43,481	3%
Street Lights	Services/Supplies	706,000	110,647	16%
Water	Personnel Services	2,166,893	535,882	25%
	Services/Supplies	4,778,418	300,135	6%
	Capital Outlay	7,676,000	614,326	8%
Water Capitalization Fees	Services/Supplies	3,900,000		
Wastewater	Personnel Services	2,911,298	614,275	21%
	Services/Supplies	6,874,376	617,708	9%
	Capital Outlay	4,710,000	368,239	8%
	Debt Service	2,176,363		
WW Capitalization	Services/Supplies	1,250,000		
Sanitation	Services/Supplies	3,959,644	802,672	20%
Public Parking	Services/Supplies	1,351,011	499,374	37%
	Capital Outlay	24,000		
Drainage	Personnel Services	118,155	30,294	26%
	Services/Supplies	798,391	85,207	11%
	Capital Outlay	905,000	259,402	29%
Total Enterprise Funds		44,305,549	4,838,161	11%
Kootenai County Solid Waste		2,885,000	470,709	16%
Police Retirement		184,241	45,828	25%
Business Improvement District		176,000	40,000	23%
Homeless Trust Fund		4,800	868	18%
Total Fiduciary Funds		3,250,041	557,405	17%
TOTALS:		\$97,303,279	\$19,093,221	20%

I HEREBY SWEAR UNDER OATH THAT THE AMOUNTS REPORTED ABOVE, ON THE CASH BASIS, ARE TRUE AND CORRECT TO THE BEST OF MY KNOWLEDGE.

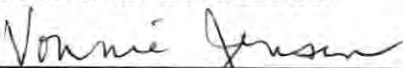

Vonnice Jensen, Comptroller, City of Coeur d'Alene, Idaho

RECEIVED

JAN - 7 2020

CITY CLERK

City of Coeur d Alene
Cash and Investments
12/31/2019

Description	City's Balance
U.S. Bank	
Checking Account	1,300,674
Checking Account	36,724
Investment Account - Police Retirement	892,462
Investment Account - Cemetery Perpetual Care Fund	1,391,857
Idaho Central Credit Union	
Certificate of Deposit	264,325
Idaho State Investment Pool	
State Investment Pool Account	41,525,006
Spokane Teacher's Credit Union	
Certificate of Deposit	252,540
Cash on Hand	
Finance Department Petty Cash	500
Treasurer's Change Fund	1,350
Police Change Fund	75
Library Change fund	180
Cemetery Change Fund	20
Total	<u><u>45,665,713</u></u>

I HEREBY SWEAR UNDER OATH THAT THE AMOUNTS REPORTED ABOVE
ARE TRUE AND CORRECT TO THE BEST OF MY KNOWLEDGE.

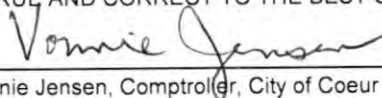

Vonnice Jensen, Comptroller, City of Coeur d'Alene, Idaho

**CITY COUNCIL
MEMORANDUM**

DATE: JANUARY 21, 2020
FROM: HILARY ANDERSON, COMMUNITY PLANNING DIRECTOR
RE: REQUEST FOR PUBLIC HEARING

I am requesting the City Council set a public hearing for the Council meeting scheduled February 4, 2020, to hear public testimony regarding the Community Development Block Grant (CDBG) Annual Action plan for Plan Year 2020.

**CITY COUNCIL
STAFF REPORT**

DATE: January 21, 2020
FROM: Dennis Grant, Engineering Project Manager
SUBJECT: **SS-19-14, Bunker Park: Final Plat Approval**

DECISION POINT

Staff is requesting the following:

1. City Council approval of the final plat document, a two (2) lot Light Manufacturing subdivision.

HISTORY

- a. Applicant: Drew Dittman, PE
Lake City Engineering, Inc.
126 E. Poplar Avenue
Coeur d'Alene, ID 83814
- b. Location: SW of the intersection of Kathleen Avenue & Schreiber Way (east entrance)
- c. Previous Action:
 1. Preliminary plat approval, December 16, 2019

FINANCIAL ANALYSIS

There are no financial issues with this development.

PERFORMANCE ANALYSIS

This Light Manufacturing development is a re-plat of an existing single lot located in Coeur d'Alene. This subdivision created two (2) lots. All conditions will be taken care of at the building permit stage; therefore, the document is ready for approval and recordation.

DECISION POINT RECOMMENDATION

City Council approval of the final plat document

BUNKER PARK

BOOK: _____ PAGE: _____
INSTRUMENT No. _____

A REPLAT OF LOT 3, BLOCK 4, COMMERCE PARK OF COEUR D'ALENE 1ST ADDITION,
LYING IN THE NORTHWEST QUARTER OF SECTION 2, TOWNSHIP 50 NORTH, RANGE 4 WEST, BOISE MERIDIAN,
CITY OF COEUR D'ALENE, KOOTENAI COUNTY, IDAHO

34 35
3 2
NORTHWEST CORNER
FOUND 3" ALUMINUM CAP
MARKED "PLS 5573" IN
MONUMENT CASE PER CP&F
INSTRUMENT NUMBER 1916540

BASIS OF BEARING
S88°58'21"E 2647.22' (P-1)
S88°58'21"E 2647.22'

35
2
NORTH QUARTER CORNER
FOUND 2-1/2" ALUMINUM CAP
MARKED "PLS 818" IN MONUMENT
CASE PER CP&F INSTRUMENT
NUMBER 1483548



BASIS OF BEARING

THE BASIS OF BEARING FOR THIS SURVEY IS SOUTH 88°58'21" EAST,
SHOWN HEREON AND ON (P-1) AS THE NORTH LINE OF THE
NORTHWEST QUARTER OF SECTION 2, TOWNSHIP 50 NORTH, RANGE 4
WEST, BOISE MERIDIAN.

NOTE

THERE WAS NO ATTEMPT MADE TO SHOW ALL OF THE PHYSICAL
FEATURES OF THIS PROPERTY, NOR ANY EASEMENTS OF RECORD,
EXCEPT FOR THOSE SHOWN HEREON.

REFERENCE DOCUMENTS

(P-1) PLAT OF COMMERCE PARK OF COEUR D'ALENE 1ST ADDITION
PREPARED BY MECKEL ENGINEERING AND SURVEYING AND FILED
AT BOOK G OF PLATS, PAGE 121, RECORDS OF KOOTENAI COUNTY,
IDAHO.

LEGEND

- SET 5/8" x 24" REBAR WITH YELLOW PLASTIC CAP MARKED "PLS 4182"
 - FOUND 2" ALUMINUM CAP MARKED "PLS 832"
 - FOUND 5/8" REBAR WITH YELLOW PLASTIC CAP MARKED "PLS 832"
 - △ CALCULATED POINT, NOTHING FOUND OR SET
 - (M) MEASURED
 - (C) CALCULATED
- BOUNDARY LINE
 - LOT LINE
 - ADJACENT LOT LINE
 - EASEMENT LINE
 - CENTER LINE
 - SECTION LINE



0 20 40 80
SCALE: 1" = 40'



LAKE CITY ENGINEERING
126 E. POPLAR AVENUE
COEUR D'ALENE, IDAHO 83814
PHONE: 208.676.0230

CHECKED BY:	DES
DRAFTED BY:	WAL
SCALE:	1" = 40'
DATE:	12/20/2019
JOB NO:	LCE 19-074

1
2

BUNKER PARK

A REPLAT OF LOT 3, BLOCK 4, COMMERCE PARK OF COEUR D'ALENE 1ST. ADDITION,
LYING IN THE NORTHWEST QUARTER OF SECTION 2, TOWNSHIP 50 NORTH, RANGE 4 WEST, BOISE MERIDIAN,
CITY OF COEUR D'ALENE, KOOTENAI COUNTY, IDAHO

BOOK: _____ PAGE: _____
INSTRUMENT No. _____

KOOTENAI COUNTY RECORDER

THIS PLAT WAS RECORDED AT THE REQUEST OF DAY, LLC, FOR RECORD IN THE OFFICE OF THE RECORDER OF KOOTENAI COUNTY, IDAHO, THIS _____ DAY OF _____, 20____, AT _____:____.M. IN BOOK OF PLATS, PAGE(S) _____, AS INSTRUMENT NUMBER _____.

FEE \$ _____

DEPUTY CLERK _____

JIM BRANNON, KOOTENAI COUNTY CLERK

CITY COUNCIL CERTIFICATE

THIS PLAT HAS BEEN ACCEPTED AND APPROVED BY CITY COUNCIL OF THE CITY OF COEUR D'ALENE, IDAHO.

DATED THIS _____ DAY OF _____, 20____.

CITY OF COEUR D'ALENE - CLERK _____

Chett W. Bandy REG #10804
CITY OF COEUR D'ALENE - CITY ENGINEER

COUNTY TREASURER'S CERTIFICATE

I HEREBY CERTIFY THAT THE TAXES DUE FOR THE PROPERTY DESCRIBED IN THE OWNERS CERTIFICATE AND DEDICATION HAVE BEEN PAID THROUGH DECEMBER 31, 2019.

DATED THIS 10th DAY OF JANUARY, 2020

Steven S. McKeown
KOOTENAI COUNTY TREASURER

HEALTH DISTRICT APPROVAL

SANITARY RESTRICTIONS AS REQUIRED BY IDAHO CODE, TITLE 50, CHAPTER 13 HAVE BEEN SATISFIED BASED ON A REVIEW BY A (QLPE) FROM THE CITY OF COEUR D'ALENE AND APPROVAL OF THE DESIGN PLANS AND SPECIFICATIONS AND THE CONDITIONS IMPOSED ON THE DEVELOPER FOR CONTINUED SATISFACTION OF THE SANITARY RESTRICTIONS. WATER AND SEWER EXTENSIONS HAVE BEEN COMPLETED AND SERVICES CERTIFIED AS AVAILABLE. SANITARY RESTRICTIONS MAY BE REIMPOSED, IN ACCORDANCE WITH SECTION 50-1326, IDAHO CODE, BY THE ISSUANCE OF A CERTIFICATE OF DISAPPROVAL.

DATED THIS 8th DAY OF JANUARY, 2020

Jan Loveland
PANHANDLE HEALTH DISTRICT 1

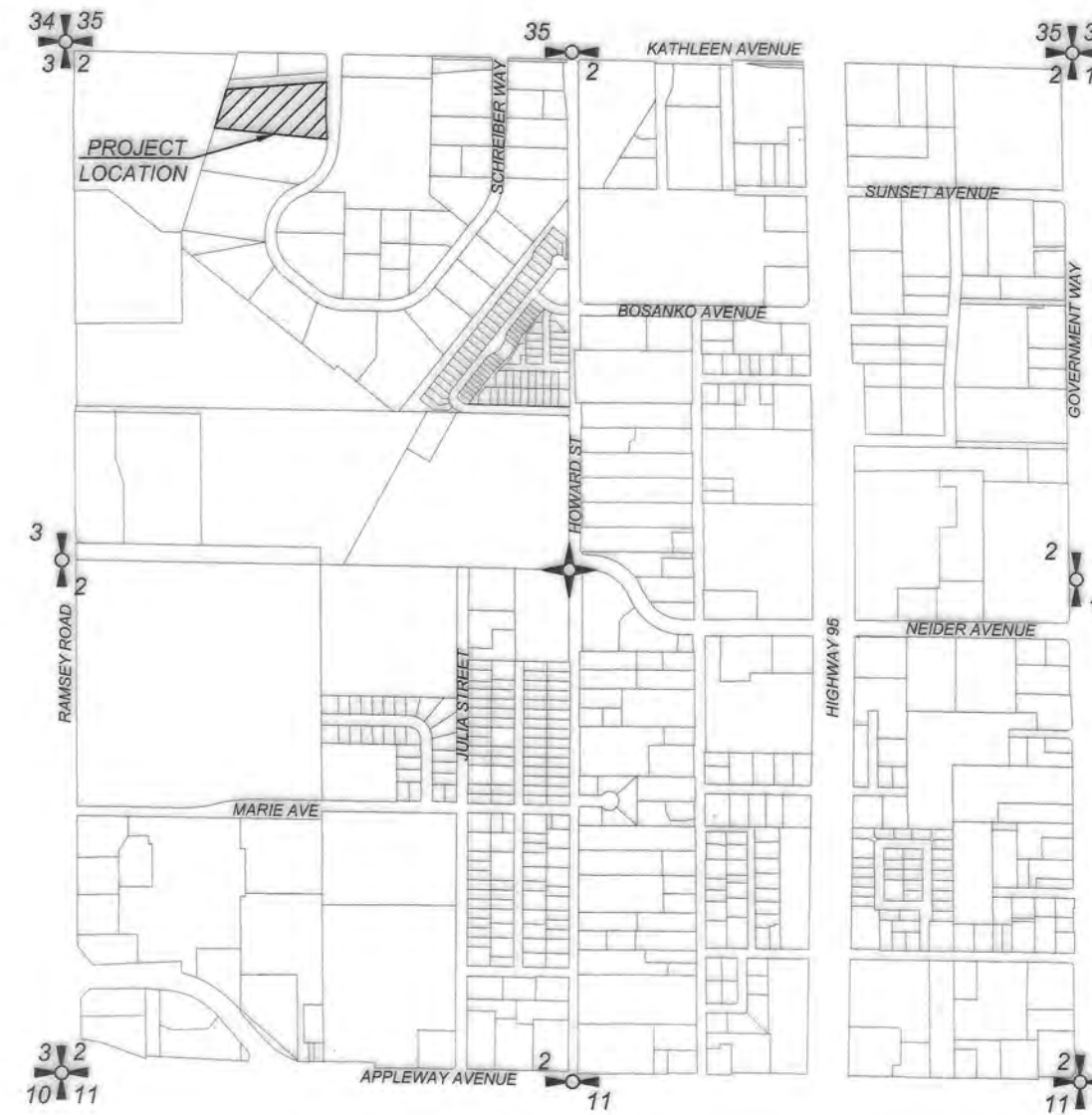

SECTION 2, TOWNSHIP 50 NORTH, RANGE 4 WEST

VICINITY MAP

SCALE 1" = 1000'

SURVEYOR'S NARRATIVE

THE PURPOSE OF THIS SURVEY WAS TO ESTABLISH THE BOUNDARY OF THE SUBJECT PROPERTY USING RECORD INFORMATION, FOUND MONUMENTATION AND THE ESTABLISHED SECTIONAL INFORMATION. WE HAVE RECOVERED IN GOOD CONDITION THE MONUMENTS OF RECORD AND HELD POSITIONS FOR EXTERIOR BOUNDARY ON THE FORGOING PLAT.

SURVEYOR'S CERTIFICATE

I, DAVID SCHUMANN, PROFESSIONAL LAND SURVEYOR #4182, STATE OF IDAHO, DO HEREBY CERTIFY THAT THE PLAT OF BUNKER PARK IS BASED UPON AN ACTUAL FIELD SURVEY OF THE LAND DESCRIBED HEREON, UNDER MY DIRECT SUPERVISION, AND ACCURATELY REPRESENTS THE POINTS PLATTED THEREON, ARE IN CONFORMITY WITH THE STATE OF IDAHO CODE RELATING TO PLATS AND SURVEYS. ALL INTERIOR CORNERS WILL BE SET, AS SHOWN ON THIS PLAT, ON OR BEFORE ONE YEAR FROM RECORDING OF THIS PLAT, IN ACCORDANCE WITH IDAHO CODE 50-1331 & 50-1303.

David Schumann
DAVID SCHUMANN DATE 1/6/2020

OWNER'S CERTIFICATE AND DEDICATION

BE IT KNOWN BY THESE PRESENTS THAT DAY LLC, AN IDAHO LIMITED LIABILITY COMPANY, DOES HEREBY CERTIFY THAT IT OWNS AND HAS LAID OUT THE LAND EMBRACED WITHIN THIS PLAT TO BE KNOWN AS BUNKER PARK, BEING A REPLAT OF LOT 3, BLOCK 4, COMMERCE PARK OF COEUR D'ALENE 1ST ADDITION, RECORDED IN BOOK G OF PLATS, PAGE 121, RECORDS OF KOOTENAI COUNTY, IDAHO, LYING IN THE NORTHWEST QUARTER OF SECTION 2, TOWNSHIP 50 NORTH, RANGE 4 WEST, BOISE MERIDIAN, CITY OF COEUR D'ALENE, KOOTENAI COUNTY, IDAHO.

LOTS WITHIN THIS PLAT ARE SUBJECT TO THE COVENANTS, CONDITIONS AND RESTRICTS OF COMMERCE PARK OF COEUR D'ALENE, RECORDED UNDER INSTRUMENT NUMBER 1258880, RECORDS OF KOOTENAI COUNTY, IDAHO, TOGETHER WITH ANY AND ALL AMENDMENTS MADE THEREAFTER;

SAID PARCEL CONTAINING 3.212 ACRES, MORE OR LESS.

BE IT FURTHER KNOWN THAT:

SANITARY SEWER DISPOSAL IS PROVIDED BY CITY OF COEUR D'ALENE;

DOMESTIC WATER FOR THIS PLAT IS SUPPLIED BY CITY OF COEUR D'ALENE;

Michael Gunning 1/8/20
D. MICHAEL GUNNING, ATTORNEY DATE

MOULTON LAW OFFICES AS GENERAL PARTNER FOR DAY, LLC

NOTARY CERTIFICATE

STATE OF WASHINGTON IDAHO

COUNTY OF SPOKANE KOOTENAI

THIS RECORD WAS ACKNOWLEDGED BEFORE ME ON THIS 8th DAY OF JANUARY IN THE YEAR 2020 BY D. MICHAEL GUNNING, ATTORNEY FOR MOULTON LAW OFFICES AS GENERAL PARTNER FOR DAY, LLC.

Andrea L. Dittman
NOTARY PUBLIC

ANDREA L. DITTMAN
COMM NO 57293
NOTARY PUBLIC
STATE OF IDAHO

MY COMMISSION EXPIRES ON 1-10-23

COUNTY SURVEYOR'S CERTIFICATE

I HEREBY CERTIFY THAT I HAVE EXAMINED THE HEREIN PLAT AND CHECKED THE PLAT COMPUTATIONS AND HAVE DETERMINED THAT THE REQUIREMENTS OF THE STATE CODE PERTAINING TO PLATS AND SURVEYS HAVE BEEN MET.

DATED THIS _____ DAY OF _____, 20____.

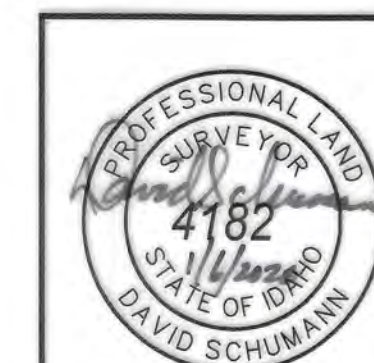

LAKE CITY ENGINEERING
126 E. POPLAR AVENUE
COEUR D'ALENE, IDAHO 83814
PHONE: 208.676.0230

CHECKED BY:	DES
DRAFTED BY:	WAL
SCALE:	N.T.S.
DATE:	12/20/2019
JOB NO:	LCE 19-074

2

2

RESOLUTION NO. 20-005

A RESOLUTION OF THE CITY OF COEUR D'ALENE, KOOTENAI COUNTY, IDAHO, AUTHORIZING THE APPROVAL OF AN AGREEMENT FOR MAINTENANCE/WARRANTY WITH GREENSTONE-KOOTENAI II, INC., FOR BOLIVAR 4TH ADDITION, AND SECURITY [S-3-6.M]; AND THE APPROVAL OF A UTILITY EASEMENT FOR A WATER LINE WITH ANDERL DEVELOPMENT, LLC, FOR 1681 W. PAMPAS LANE.

WHEREAS, it has been recommended that the City of Coeur d'Alene approve the actions listed below, pursuant to the terms and conditions set forth in the contracts and agreements, and other action documents attached hereto as Exhibits "A" through "B" and by reference made a part hereof as summarized as follows:

- A) Approval of an Agreement for Maintenance/Warranty with Greenstone-Kootenai II, Inc., for Bolivar 4th Addition, and Security [S-3-6.m];
- B) Approval of a Utility Easement for a Water Line with Anderl Development, LLC, for 1681 W. Pampas Lane; and

WHEREAS, it is deemed to be in the best interests of the City of Coeur d'Alene and the citizens thereof to enter into such agreements or other actions;

NOW, THEREFORE,

BE IT RESOLVED by the Mayor and City Council of the City of Coeur d'Alene that the City approve the actions for the subject matter, as set forth in substantially the form attached hereto as Exhibits "A" through "B" and incorporated herein by reference, with the provision that the Mayor, City Administrator, and City Attorney are hereby authorized to modify said contracts and agreement, and the other actions, so long as the substantive provisions of the contracts and agreement, and the other actions remain intact.

BE IT FURTHER RESOLVED that the Mayor and City Clerk be and they are hereby authorized to execute such contracts and agreements, or other documents as may be required on behalf of the City.

DATED this 21st day of January, 2020.

Steve Widmyer, Mayor

ATTEST

Renata McLeod, City Clerk

Motion by _____, Seconded by _____, to adopt the foregoing resolution.

ROLL CALL:

COUNCIL MEMBER ENGLISH Voted _____

COUNCIL MEMBER EVANS Voted _____

COUNCIL MEMBER MILLER Voted _____

COUNCIL MEMBER MCEVERS Voted _____

COUNCIL MEMBER GOOKIN Voted _____

COUNCIL MEMBER WOOD Voted _____

_____ was absent. Motion _____.

CITY COUNCIL STAFF REPORT

DATE: January 21, 2020
FROM: Dennis J. Grant, Engineering Project Manager
SUBJECT: **S-3-16.m Bolivar 4th Addition: Acceptance of Improvements, Maintenance/Warranty Agreement and Security Approval**

DECISION POINT

Staff is requesting the following:

1. Acceptance of the installed public infrastructure improvements.
2. Approval of the Maintenance/Warranty Agreement and Security.

HISTORY

- a. Applicant: Kevin Schneidmiller, Vice President
Greenstone-Kootenai II, Inc.
1421 N. Meadowwood Lane, Suite 200
Liberty Lake, WA 99019
- b. Location: East of Atlas Rd., South of Hanley Ave., West of Bolivar 2nd Addition, and North of Bolivar 3rd Addition.
- c. Previous Action:
 1. Final plat approval, Bolivar Addition in 2003.
 2. Final plat approval, Bolivar 1st Addition in 2005.
 3. Final plat approval, Bolivar 2nd Addition 2006.
 4. Final plat approval, Bolivar 3rd Addition in 2017.
 5. Final plat approval, Bolivar 4th Addition in 2019.

FINANCIAL ANALYSIS

The developer is installing the required warranty bond (10%) to cover any maintenance issues that may arise during the one (1) year warranty period that will commence upon this approval, and terminate, on January 21, 2021. The amount of the security provided is \$65,616.00.

PERFORMANCE ANALYSIS

The developer has installed all required public infrastructure. The responsible City departments have approved the installations and found them ready to accept. Acceptance of the installed improvements will allow the issuance of all available building permits for this phase of the development, and, Certificate of Occupancy issuance upon completion. The City maintenance would be required to start after the one (1) year warranty period expires on January 21, 2021.

DECISION POINT RECOMMENDATION

1. Acceptance of the installed public infrastructure improvements.
2. Approval of the Maintenance/Warranty Agreement and accompanying Security.

AGREEMENT FOR MAINTENANCE/WARRANTY OF SUBDIVISION WORK
Bolivar 4th Addition

THIS AGREEMENT made this 21st day of January, 2020 between Greenstone-Kootenai II, Inc., whose address is 1421 N. Meadowwood Lane, Suite 200, Liberty Lake, WA 99019, with Kevin Schneidmiller, Vice-President, hereinafter referred to as the "**Developer**," and the city of Coeur d'Alene, a municipal corporation and political subdivision of the state of Idaho, whose address is City Hall, 710 E. Mullan Avenue, Coeur d'Alene, ID 83814, hereinafter referred to as the "**City**";

WHEREAS, the City has approved the final subdivision plat of Bolivar 4th Addition, a sixty (27) lot, residential development in Coeur d'Alene, situated in the Northwest Quarter of Section 34, Township 51 North, Range 4 West, Boise Meridian, Kootenai County, Idaho; and

WHEREAS, the Developer completed the installation of certain public improvements in the noted subdivision as required by Title 16 of the Coeur d'Alene Municipal Code and is required to warrant and maintain the improvements for one year; NOW, THEREFORE,

IT IS AGREED AS FOLLOWS:

The Developer agrees to maintain and warrant for a period of one year from the approval date of this agreement, the public improvements listed in the attached spreadsheet, attached as Exhibit "A", and, as shown on the construction plans entitled "Bolivar 4th Addition", signed and stamped by Doug J. Desmond, PE, # 10886, dated April 18, 2019, incorporated herein by reference, including but not limited to: sanitary sewer system and appurtenances, potable water system and appurtenances, catch basins, stormwater drainage swales, drywells and appurtenances, concrete curb and sidewalk including ramps, asphalt paving, street luminaires, signing and monumentation as required under Title 16 of the Coeur d'Alene Municipal Code.

The Developer herewith delivers to the City, security in a form acceptable to the City, for the amount of Sixty-Five Thousand Six hundred sixteen and 00/100 Dollars (\$65,616.00) securing the obligation of the Developer to maintain and warrant the public subdivision improvements referred to herein. The security shall not be released until the 21st day of January, 2021. The City Inspector will conduct a final inspection prior to the release of the security to verify that all installed improvements are undamaged and free from defect. In the event that the improvements made by the Developer were not maintained or became defective during the period set forth above, the City may demand the funds represented by the security and use the proceeds to complete maintenance or repair of the improvements thereof. The Developer further agrees to be responsible for all costs of warranting and maintaining said improvements above the amount of the security given.

Owner's Reimbursement to the City: The Parties further agree that the City has utilized substantial staff time to prepare this agreement, which will benefit the Owner. The Parties further agree the City should be reimbursed a reasonable fee for its costs to prepare such agreement. The Parties further agree that such fee should be in the amount of Twenty Five and No/100 Dollars (\$25.00).

IN WITNESS WHEREOF, the parties have set their hands and seal the day and year first above written.

City of Coeur d'Alene

Greenstone-Kootenai II, Inc.

Steve Widmyer, Mayor



Kevin Schneidmiller, Vice-President

ATTEST:

Renata McLeod, City Clerk

EXHIBIT 'A'

Project Name:		Bolivar 4th						
Expenses		You can change the row headings, but don't add any, if possible (i.e. you could change "mounding" to "blasting").						
		average depth	1	1	1			
		ROW width	50	50	50			
9-0120	Storm Drainage	Single Depth DW				\$ 2,355.00	0	0
		Double Depth DW			1	\$ 2,800.00	2,800	0
		Sidewalk Vaults			1	\$ 950.00	950	0
		208' ponds			1500	\$ 1.20	1,800	0
		Hydroseed			1500	\$ 0.20	300	0
								5,648
9-0130	Sewer	8" mainline	261	280	259	\$ 36.00	28,800	0
		Manholes	1		1	\$ 4,700.00	9,400	0
		services	13	3	10	\$ 800.00	20,800	0
		Tie in	1		1	\$ 1,200.00	2,400	0
								52,666
9-0140	Water	8" mainline	285	280	409	\$ 37.00	36,038	0
		Fire Hydrants		2		\$ 5,500.00	11,000	0
		blow offs			1	\$ 900.00	900	0
		Services	13	3	10	\$ 2,000.00	52,000	0
		irrigation service			2	\$ 15,000.00	30,000	0
		irrigation sleeving	90	90	290	\$ 16.00	7,520	0
		Tie In	1		2	\$ 1,550.00	4,650	0
								142,108
9-0150	Paving	3" on 4"	14454	6032	12428	\$ 2.00	65,828	0
								57,816
9-0151	Curbing	Rolled Curb	738	532	1158	\$ 13.00	31,564	0
								26,645
9-0152	Sidewalk	width	5 feet					
		ada domes S.F	0	2	2	\$ 800.00	4,800	0
								40,765
9-0180	Street Signs	street signs		2	1	\$ 400.00	1,200	0
								1,200
	Construction costs							656,161
	Warranty Bond Amount 10%							\$ 65,616

UTILITY EASEMENT FOR WATER LINE

KNOW ALL MEN BY THESE PRESENTS, that Anderl Development, LLC, with its principle place of business at 2875 East Spyglass Court, Coeur d'Alene, ID, 83815, the **GRANTOR**, for and in consideration of the sum of One Dollar (\$1.00), and other good and valuable consideration, paid by the City of Coeur d'Alene, Kootenai County, State of Idaho, receipt of which is acknowledged, do hereby grant, quitclaim and convey unto the **CITY OF COEUR D'ALENE**, a municipal corporation, the **GRANTEE**, whose address is 710 Mullan Avenue, Coeur d'Alene, Idaho, 83814, its successors and assigns, an easement, together with the rights of ingress and egress for the improvement, operation and maintenance of the water line, varying in width, over and through the property situated in Kootenai County with an address of 1681 West Pampas Lane, which easement is described in Exhibit "A" and Exhibit "C" and depicted on Exhibit "B" and Exhibit "D" attached hereto and incorporated herein by reference.

The **GRANTOR** further agrees to keep the easement clear of all buildings, structures, and other obstructions, not to include the storage of removable items. The **GRANTOR** agrees that all underground facilities installed by or for the **GRANTEE** shall remain the property of the **GRANTEE**, removable by the **GRANTEE** at its option.

Should it be necessary for the **GRANTEE** to remove fencing, remove or damage any asphalt, concrete or their surfacing for the maintenance or repair of the underground facility, the **GRANTEE** shall repair and restore them to their original condition at the expense of the **GRANTEE**.

TO HAVE AND TO HOLD such easement for public purposes so long as the same shall be used, operated and maintained as such.

IN WITNESS WHEREOF, the **GRANTORS** have caused this instrument to be executed this ____ day of _____, 20__.

Tom Anderl, Member
Anderl Development, LLC

STATE OF IDAHO)
)ss.
COUNTY OF KOOTENAI)

On this ____ day of _____ 20____, before me, the subscriber, a Notary Public in and for said State and County, personally appeared Tom Anderl, a Member of Anderl Development, LLC, known or subscribed and sworn to me to be the person whose name is subscribed to the within instrument, and in due form of law acknowledged that he is authorized on behalf of said limited liability company to execute all documents pertaining hereto and acknowledged to me that he executed the same as his/her voluntary act and deed on behalf of said limited liability company.

IN TESTIMONY WHEREOF, I have hereunto set my hand and affixed my seal in said State and County on the day and year last above written.

Notary Public

Residing at: _____

My Commission Expires: _____

Exhibit A

Water Easement Land Description

A portion of Coeur d'Alene Place 2nd Addition filed at Book K of Plats, Page 431, Records of Kootenai County, Idaho and Coeur d'Alene, filed at Book G of Plats, Page 396, Records of Kootenai County, Idaho, situate in the southeast quarter of the southeast quarter of Section 27, Township 51 North, Range 4 West, Boise Meridian, City of Coeur d'Alene, Kootenai County, Idaho and more particularly described as follows:

Commencing at the southwest corner of the parcel as shown on the Record of Survey prepared by CLC Associates and recorded in Book 27 of Surveys, Page 169, Records of Kootenai County, Idaho, being a 5/8 inch rebar with orange plastic cap marked "MEM 9717" from which the southeast corner bears, South 89°55'28" East 277.63 feet; thence along the southerly line of said parcel, South 89°55'28" East 131.63 feet to the **True Point of Beginning**;

thence continuing along said southerly line, South 89°55'28" East 20.00 feet;

thence leaving said southerly line, South 00°04'32" West 29.02 feet;

thence along the following 15 (fifteen) courses:

- 1) thence South 89°55'28" East 153.384 feet;
- 2) thence North 01°18'39" East 235.90 feet;
- 3) thence North 46°18'39" East 154.67 feet;
- 4) thence South 89°26'10" East 183.52 feet;
- 5) thence North 45°33'50" East 41.64 feet;
- 6) thence North 00°33'40" East 166.51 feet;
- 7) thence North 45°33'40" East 57.32 feet;
- 8) thence North 68°03'40" East 65.05 feet;
- 9) thence along a non-tangent curve to the left with a radius of 490.00 feet, an arc length of 123.35 feet; a central angle of 14°25'25" and a long chord that bears North 60°50'58" East 123.03 feet;
- 10) thence North 53°38'15" East 22.50 feet;
- 11) thence along a non-tangent curve to the right with a radius of 260.00, an arc length of 167.58 feet, a central angle of 36°55'43" and a long chord that bears North 72°06'07" East 164.69 feet;
- 12) thence South 89°26'02" East 62.83 feet;
- 13) thence South 44°26'02" East 103.11 feet;
- 14) thence South 00°33'58" West 199.02 feet;
- 15) thence South 89°26'02" East 54.59 feet to the East line of Parcel C as shown on the Record of Survey prepared by CLC Associates and recorded in Book 20, Page 315, Records of Kootenai County, Idaho;

thence along said East line, South 00°33'58" West 20.00 feet;

thence leaving said East line, North 89°26'02" West 54.59 feet;

thence along the following 32 (thirty-two) courses:

- 1) thence South 00°33'58" West 94.06 feet;
- 2) thence South 45°33'58" West 28.29 feet;
- 3) thence North 89°26'02" West 82.37 feet;
- 4) thence South 49°50'15" West 93.05 feet;
- 5) thence South 40°09'45" East 10.69 feet;
- 6) thence South 49°50'15" West 20.00 feet;
- 7) thence North 40°09'45" West 10.69 feet;
- 8) thence South 49°50'15" West 8.86 feet;
- 9) thence South 04°50'15" West 17.60 feet;
- 10) thence South 85°09'45" East 15.07 feet;
- 11) thence South 04°50'15" West 20.00 feet;
- 12) thence North 85°09'45" West 15.07 feet;
- 13) thence South 04°50'15" West 29.86 feet;
- 14) thence along a non-tangent curve to the right with a radius of 260.00 feet, an arc length of 11.60 feet, a central angle of 02°33'25" and a long chord that bears South 06°06'58" West 11.60 feet;
- 15) thence South 81°03'45" East 38.23 feet;
- 16) thence South 08°56'15" West 20.00 feet;
- 17) thence North 81°03'45" West 38.46 feet;
- 18) thence along a non-tangent curve to the right with a radius of 260.00 feet, an arc length of 69.64 feet; a central angle of 15°20'44" and a long chord that bears South 19°28'34" West 69.43 feet;
- 19) thence South 27°08'57" West 34.64 feet;
- 20) thence South 72°08'57" West 80.24 feet;
- 21) thence South 17°51'03" East 40.58 feet;
- 22) thence South 72°08'57" West 20.00 feet;
- 23) thence North 17°51'03" West 40.58 feet;
- 24) thence South 72°08'57" West 100.73 feet;
- 25) thence South 17°51'03" East 30.24 feet;
- 26) thence South 72°08'57" West 20.00 feet;
- 27) thence North 17°51'03" West 30.24 feet;
- 28) thence South 72°08'57" West 98.76 feet;
- 29) thence along a non-tangent curve to the right with a radius of 310.00 feet, an arc length of 112.44 feet, a central angle of 20°46'57" and a long chord that bears South 82°32'25" West 111.83 feet;
- 30) thence South 04°46'48" West 18.69 feet;
- 31) thence along a non-tangent curve to the right with a radius of 310.00 feet, an arc length of 28.31 feet, a central angle of 05°13'59" and a long chord that bears South 07°23'48" West 28.30 feet;

32) thence South 10°00'48" West 88.81 feet to the South line of Parcel E of said Record of Survey;

thence along said South line, along a non-tangent curve to the left with a radius of 1650.00 feet, an arc length of 20.00 feet, a central angle of 00°41'40" and a long chord that bears North 80°22'12" West 20.00 feet;

thence leaving said South line, North 10°00'48" East 88.94 feet;

thence along the following 14 (fourteen) courses:

- 1) thence along a non-tangent curve to the left with a radius of 290.00 feet, an arc length of 26.49 feet, a central angle of 05°13'59" and a long chord that bears North 07°23'48" East 26.48 feet;
- 2) thence North 04°46'48" East 18.69 feet;
- 3) thence along a non-tangent curve to the right with a radius of 310.00 feet, an arc length of 4.48 feet, a central angle of 00°49'42" and a long chord that bears North 82°57'26" West 4.48 feet;
- 4) thence South 11°09'22" West 21.28 feet;
- 5) thence North 78°50'38" West 10.00 feet;
- 6) thence South 11°09'22" West 20.20 feet;
- 7) thence North 78°50'38" West 20.00 feet;
- 8) thence North 11°09'22" East 40.99 feet;
- 9) thence along a non-tangent curve to the right with a radius 310.00 feet, an arc length of 56.59 feet; a central angle of 10°27'31" and a long chord that bears North 71°45'58" West 56.51 feet;
- 10) thence North 66°32'12" West 55.57 feet;
- 11) thence North 89°55'28" West 219.46 feet;
- 12) thence North 00°04'32" East 30.70 feet;
- 13) thence South 89°55'28" East 17.18 feet;
- 14) thence North 00°04'32" East 18.32 feet to the **True Point of Beginning**;

as depicted on Exhibit B Sheet 1 of 4;

EXCEPTING THEREFROM:

Commencing at the southeast corner of the parcel as shown on the Record of Survey prepared by CLC Associates and recorded in Book 27 of Surveys, Page 169, Records of Kootenai County, Idaho, being a 5/8 inch rebar with orange plastic cap marked "MEM 9717" from which the southwest corner bears, North 89°55'28" West 277.63 feet; thence leaving said southerly line, South 58°26'09" East 55.57 feet to the **True Point of Beginning**;

thence North 01°18'39" East 200.33 feet;

thence South 88°41'21" East 41.80 feet;

thence North 01°18'39" East 20.00 feet;

thence North 88°41'21" West 41.80 feet;
thence North 01°18'39" East 6.85 feet;
thence North 46°18'39" East 66.22 feet;
thence South 43°41'21" East 25.47 feet;
thence North 46°18'39" East 20.00 feet;
thence North 43°41'21" West 25.47 feet;
thence North 46°18'39" East 46.36 feet;
thence South 00°33'50" West 39.65 feet;
thence South 89°26'10" East 20.00 feet;
thence North 00°33'50" East 43.61 feet;
thence South 89°26'10" East 167.74 feet;
thence North 45°33'50" East 58.21 feet;
thence North 00°33'40" East 41.75 feet;
thence South 89°26'20" East 42.00 feet;
thence North 00°33'40" East 20.00 feet;
thence North 89°26'20" West 42.00 feet;
thence North 00°33'40" East 12.50 feet;
thence South 89°26'02" East 41.00 feet;
thence North 00°33'58" East 20.00 feet;
thence North 89°26'02" West 41.00 feet;
thence North 00°33'40" East 72.25 feet;
thence North 45°33'40" East 45.06 feet;
thence North 68°03'40" East 61.07 feet;
thence along a non-tangent curve to the left with a radius of 510.00 feet, an arc length of 109.08 feet, a central angle of 12°15'17" and a long chord that bears North 61°56'02" East 108.87 feet;
thence South 36°21'45" East 42.37 feet;
thence North 53°38'12" East 47.00 feet;
thence North 36°21'45" West 41.94 feet;

thence along a non-tangent curve to the right with a radius of 240.00 feet, an arc length of 59.04 feet; a central angle of 14°05'39" and a long chord that bears North 61°55'31" East 58.89 feet;

thence South 18°16'52" East 32.97 feet;

thence North 71°43'08" East 20.00 feet;

thence North 18°16'52" West 33.10 feet;

thence along a non-tangent curve to the right with a radius of 240.00 feet, an arc length of 70.45 feet; a central angle of 16°49'03" and a long chord that bears North 82°09'27" East 70.19 feet;

thence South 89°26'02" East 54.55 feet;

thence South 44°26'02" East 86.54 feet;

thence South 00°33'58" West 104.12 feet;

thence North 89°26'02" West 8.28 feet;

thence North 78°24'15" West 29.15 feet;

thence South 11°35'45" West 20.00 feet;

thence South 78°24'15" East 31.08 feet;

thence South 89°26'02" East 10.21 feet;

thence South 00°33'58" West 22.52 feet;

thence North 89°26'02" West 44.60 feet;

thence South 00°33'58" West 20.00 feet;

thence South 89°26'02" East 44.60 feet;

thence South 00°33'58" West 129.88 feet;

thence South 45°33'58" West 11.72 feet;

thence North 89°26'02" West 81.51 feet;

thence South 49°50'15" West 28.98 feet;

thence North 40°09'45" West 102.18 feet;

thence South 49°50'15" West 20.00 feet;

thence South 40°09'45" East 102.18 feet;

thence South 49°50'15" West 88.64 feet;

thence South 04°50'15" West 75.75 feet;

thence along a non-tangent curve to the right with a the right with a radius of 240.00 feet, an arc length of 93.46, a central angle of 22°18'41" and a long chord that bears South 15°59'36" West 92.87 feet;

thence South 27°08'57" West 26.36 feet;

thence South 72°08'57" West 89.50 feet;

thence North 17°51'03" West 28.63 feet;

thence South 72°08'57" West 20.00 feet;

thence South 17°51'03" East 28.63 feet;

thence South 72°08'57" West 19.55 feet;

thence North 17°51'03" West 33.58 feet;

thence South 72°08'57" West 31.04 feet;

thence South 17°51'03" East 33.58 feet;

thence South 72°08'57" West 151.35 feet;

thence along a curve to the right with a radius of 290.00 feet, an arc length of 209.11 feet, a central angle of 41°18'51" and a long chord that bears North 87°11'38" West 204.61 feet;

thence North 66°32'12" West 59.71 feet;

thence North 89°55'28" West 13.03 feet to the **True Point of Beginning**;

as depicted on Exhibit B Sheet 2 of 4;

said strip containing 1.795 acres of land, more or less.



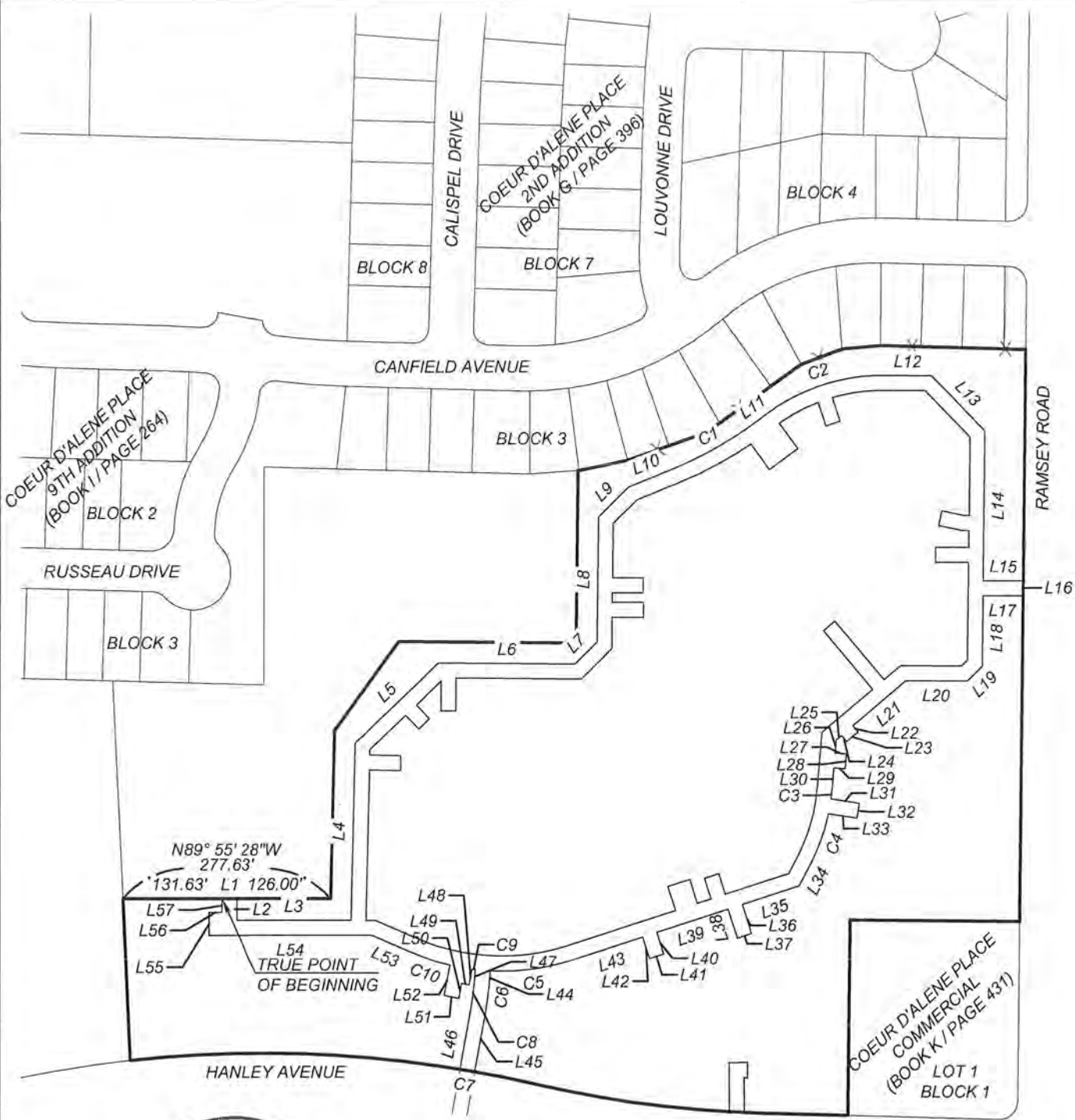

SCALE: 1" = 200'

Resolution No. 20-005

126 E. POPLAR AVENUE
 COEUR D'ALENE, IDAHO 83814
 PHONE: 208.676.0230
 WWW.LAKECITYENGINEERING.COM

EXHIBIT B
WATER EASEMENT

SEC 27, T51N, R4W, B.M.
 CITY OF COEUR D'ALENE, IDAHO

DESIGNED BY:	DHL
DRAFTED BY:	WAL
SCALE:	1" = 200'
DATE:	7/03/2019
JOB NO:	LCE 17-094
FILE:	17-094-WTR-ESMT.dwg

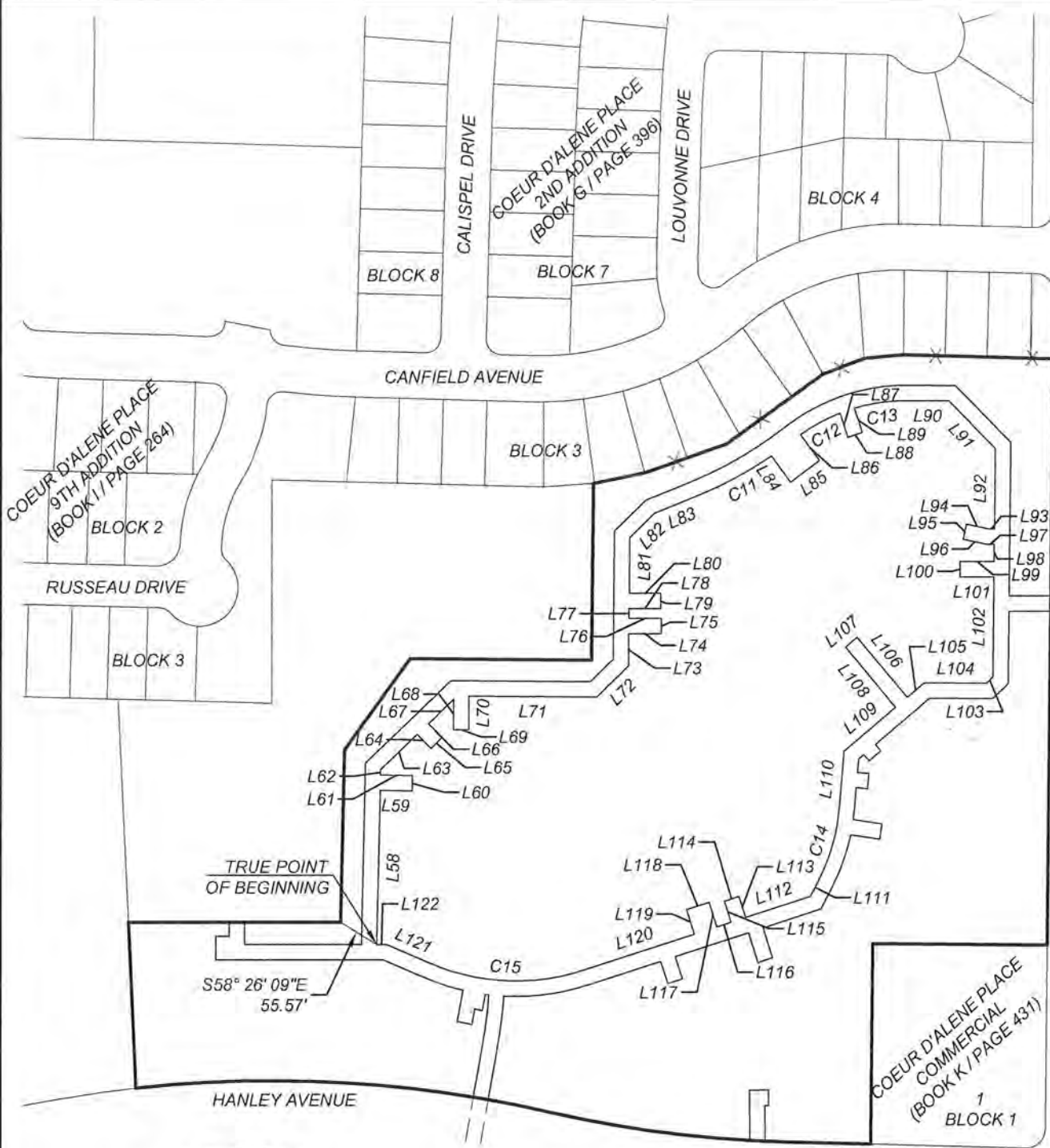

SCALE: 1" = 200'



126 E. POPLAR AVENUE
 COEUR D'ALENE, IDAHO 83814
 PHONE 208.676.0230
 WWW.LAKECITYENGINEERING.COM

Resolution No. 20-005

EXHIBIT B
WATER EASEMENT

SEC 27, T51N, R4W, B.M.
 CITY OF COEUR D'ALENE, IDAHO

DESIGNED BY:	DHL
DRAFTED BY:	WAL
SCALE:	1" = 200'
DATE:	7/03/2019
JOB NO:	LCE 17-094
FILE:	17-094-WTR ESMT.dwg

Exhibit "B"

Line Table		
Line #	Bearing	Length
L1	N89°55'28"W	20.00'
L2	N00°04'32"E	29.02'
L3	S89°55'28"E	153.38'
L4	N01°18'39"E	235.90'
L5	N46°18'39"E	154.67'
L6	S89°26'10"E	183.52'
L7	N45°33'50"E	41.64'
L8	N00°33'40"E	166.51'
L9	N45°33'40"E	57.32'
L10	N68°03'40"E	65.05'
L11	N53°38'15"E	22.50'
L12	S89°26'02"E	62.83'
L13	S44°26'02"E	103.11'
L14	S00°33'58"W	199.02'
L15	S89°26'02"E	54.59'
L16	N00°33'58"E	20.00'
L17	S89°26'02"E	54.59'
L18	S00°33'58"W	94.06'
L19	S45°33'58"W	28.29'
L20	N89°26'02"W	82.37'
L21	S49°50'15"W	93.05'
L22	S40°09'45"E	10.69'
L23	S49°50'15"W	20.00'
L24	N40°09'45"W	10.69'
L25	S49°50'15"W	8.86'
L26	S04°50'15"W	17.60'
L27	S85°09'45"E	15.07'
L28	S04°50'15"W	20.00'
L29	N85°09'45"W	15.07'
L30	S04°50'15"W	29.86'
L31	S81°03'45"E	38.23'

Line Table		
Line #	Bearing	Length
L32	S08°56'15"W	20.00'
L33	N81°03'45"W	38.46'
L34	S27°08'57"W	34.64'
L35	S72°08'57"W	80.24'
L36	S17°51'03"E	40.58'
L37	S72°08'57"W	20.00'
L38	N17°51'03"W	40.58'
L39	S72°08'57"W	100.73'
L40	S17°51'03"E	30.24'
L41	S72°08'57"W	20.00'
L42	N17°51'03"W	30.24'
L43	S72°08'57"W	98.76'
L44	S04°46'48"W	18.69'
L45	S10°00'48"W	88.81'
L46	N10°00'48"E	88.94'
L47	N04°46'48"E	18.69'
L48	S11°09'22"W	21.28'
L49	N78°50'38"W	10.00'
L50	S11°09'22"W	20.20'
L51	N78°50'38"W	20.00'
L52	N11°09'22"E	40.99'
L53	N66°32'12"W	55.57'
L54	N89°55'28"W	219.46'
L55	N00°04'32"E	30.70'
L56	S89°55'28"E	17.18'
L57	N00°04'32"E	18.32'
L58	N01°18'39"E	200.33'
L59	S88°41'21"E	41.80'
L60	N01°18'39"E	20.00'
L61	N88°41'21"W	41.80'
L62	N01°18'39"E	6.85'

Line Table		
Line #	Bearing	Length
L63	N46°18'39"E	66.22'
L64	S43°41'21"E	25.47'
L65	N46°18'39"E	20.00'
L66	S43°41'21"E	25.47'
L67	N46°18'39"E	46.36'
L68	N00°33'50"E	39.65'
L69	N89°26'10"W	20.00'
L70	N00°33'50"E	43.61'
L71	S89°26'10"E	167.74'
L72	N45°33'50"E	58.21'
L73	N00°33'40"E	41.75'
L74	S89°26'20"E	42.00'
L75	N00°33'40"E	20.00'
L76	N89°26'20"W	42.00'
L77	N00°33'40"E	12.50'
L78	S89°26'02"E	41.00'
L79	N00°33'58"E	20.00'
L80	N89°26'02"W	41.00'
L81	N00°33'40"E	72.25'
L82	N45°33'40"E	45.06'
L83	N68°03'40"E	61.07'
L84	S36°21'45"E	42.37'
L85	N53°38'12"E	47.00'
L86	N36°21'45"W	41.94'
L87	S18°16'52"E	32.97'
L88	N71°43'08"E	20.00'
L89	N18°16'52"W	33.10'
L90	S89°26'02"E	54.55'
L91	S44°26'02"E	86.54'
L92	S00°33'58"W	104.12'
L93	N89°26'02"W	8.28'

Line Table		
Line #	Bearing	Length
L94	N78°24'15"W	29.15'
L95	S11°35'45"W	20.00'
L96	S78°24'15"E	31.08'
L97	S89°26'02"E	10.21'
L98	S00°33'58"W	22.52'
L99	N89°26'02"W	44.60'
L100	S00°33'58"W	20.00'
L101	S89°26'02"E	44.60'
L102	S00°33'58"W	129.88'
L103	S45°33'58"W	11.72'
L104	N89°26'02"W	81.51'
L105	S49°50'15"W	28.98'
L106	N40°09'45"W	102.18'
L107	S49°50'15"W	20.00'
L108	S40°09'45"E	102.18'
L109	S49°50'15"W	88.64'
L110	S04°50'15"W	75.75'
L111	S27°08'57"W	26.36'
L112	S72°08'57"W	89.50'
L113	N17°51'03"W	28.63'
L114	S72°08'57"W	20.00'
L115	S17°51'03"E	28.63'
L116	S72°08'57"W	19.55'
L117	N17°51'03"W	33.58'
L118	N72°08'57"E	31.04'
L119	S17°51'03"E	33.58'
L120	S72°08'57"W	151.35'
L121	N66°32'12"W	59.71'
L122	N89°55'28"W	13.03'



3 of 4



126 E. POPLAR AVENUE
COEUR D'ALENE, IDAHO 83814
PHONE: 208.676.0230
WWW.LAKECITYENGINEERING.COM

Resolution No. 20-005

EXHIBIT B WATER EASEMENT

SEC 27, T51N, R4W, B.M.
CITY OF COEUR D'ALENE, IDAHO

DESIGNED BY:	DHL
DRAFTED BY:	WAL
SCALE:	N/A
DATE:	7/03/2019
JOB NO:	LCE 17-094
FILE:	17-094-WTR-ESMT.dwg

Exhibit "B"

Curve Table					
Curve #	Length	Radius	Delta	Bearing	Chord
C1	123.35'	490.00'	014°25'25"	N60°50'58"E	123.03'
C2	167.58'	260.00'	036°55'43"	S72°06'07"W	164.69'
C3	11.60'	260.00'	002°33'25"	S06°06'58"W	11.60'
C4	69.64'	260.00'	015°20'44"	S19°28'34"W	69.43'
C5	112.44'	310.00'	020°46'57"	S82°32'25"W	111.83'
C6	28.31'	310.00'	005°13'59"	S07°23'48"W	28.30'
C7	20.00'	1650.00'	000°41'40"	N80°22'12"W	20.00'
C8	26.49'	290.00'	005°13'59"	N07°23'48"E	26.48'
C9	4.48'	310.00'	000°49'42"	N82°57'26"W	4.48'
C10	56.59'	310.00'	010°27'31"	N71°45'58"W	56.51'
C11	109.08'	510.00'	012°15'17"	N61°56'02"E	108.87'
C12	59.04'	240.00'	014°05'39"	N61°55'31"E	58.89'
C13	70.45'	240.00'	016°49'03"	N82°09'27"E	70.19'
C14	93.46'	240.00'	022°18'41"	S15°59'36"W	92.87'
C15	209.11'	290.00'	041°18'51"	N87°11'38"W	204.61'



126 E. POPLAR AVENUE
 COEUR D'ALENE, IDAHO 83814
 PHONE 208.676.0230
 WWW.LAKECITYENGINEERING.COM

Resolution No. 20-005

EXHIBIT B
WATER EASEMENT

SEC 27, T51N, R4W, B.M.
CITY OF COEUR D'ALENE, IDAHO

DESIGNED BY:	DHL
DRAFTED BY:	WAL
SCALE:	N/A
DATE:	7/03/2019
JOB NO:	LCE 17-094
FILE:	17-094-WTR-ESMT.dwg

Exhibit "B"

Exhibit C

Water Easement Land Description

A portion of Lot 2, Block 1, Coeur d'Alene Place Commercial, filed at Book K of Plats, Page 431, Records of Kootenai County, Idaho, situate in the southeast quarter of the southeast quarter of Section 27, Township 51 North, Range 4 West, Boise Meridian, City of Coeur d'Alene, Kootenai County, Idaho and more particularly described as follows:

Commencing at the southeast corner of said Lot 2, Block 1, being a point on the northerly Right-of-Way of Hanley Avenue, from which the northwest corner of Lot 1, Block 1, bears North 00°33'54" East 259.98 feet; thence along the said northerly Right-of-Way, North 88°25'36" West 114.74 feet; thence continuing along said northerly Right-of-Way, along a non-tangent curve to the right with a radius of 1550.00 feet, an arc length of 23.83 feet, a central angle of 00°52'52" and a long chord that bears North 87°59'08" West 23.83 feet to the **True Point of Beginning**;

thence continuing along said northerly Right-of-Way, along a non-tangent curve with a radius of 1550.00 feet, an arc length of 20.04 feet, a central angle of 00°44'27" and a long chord that bears North 87°10'29" West 20.04 feet;

thence leaving said northerly Right-of-Way, North 00°46'56" West 65.22 feet;

thence North 89°13'04" East 25.00 feet;

thence South 00°46'56" East 20.00 feet;

thence South 89°13'04" West 5.00 feet;

thence South 00°46'56" East 46.48 feet to the **True Point of Beginning**;

containing 1417 square feet of land, more or less;

as depicted on Exhibit D.



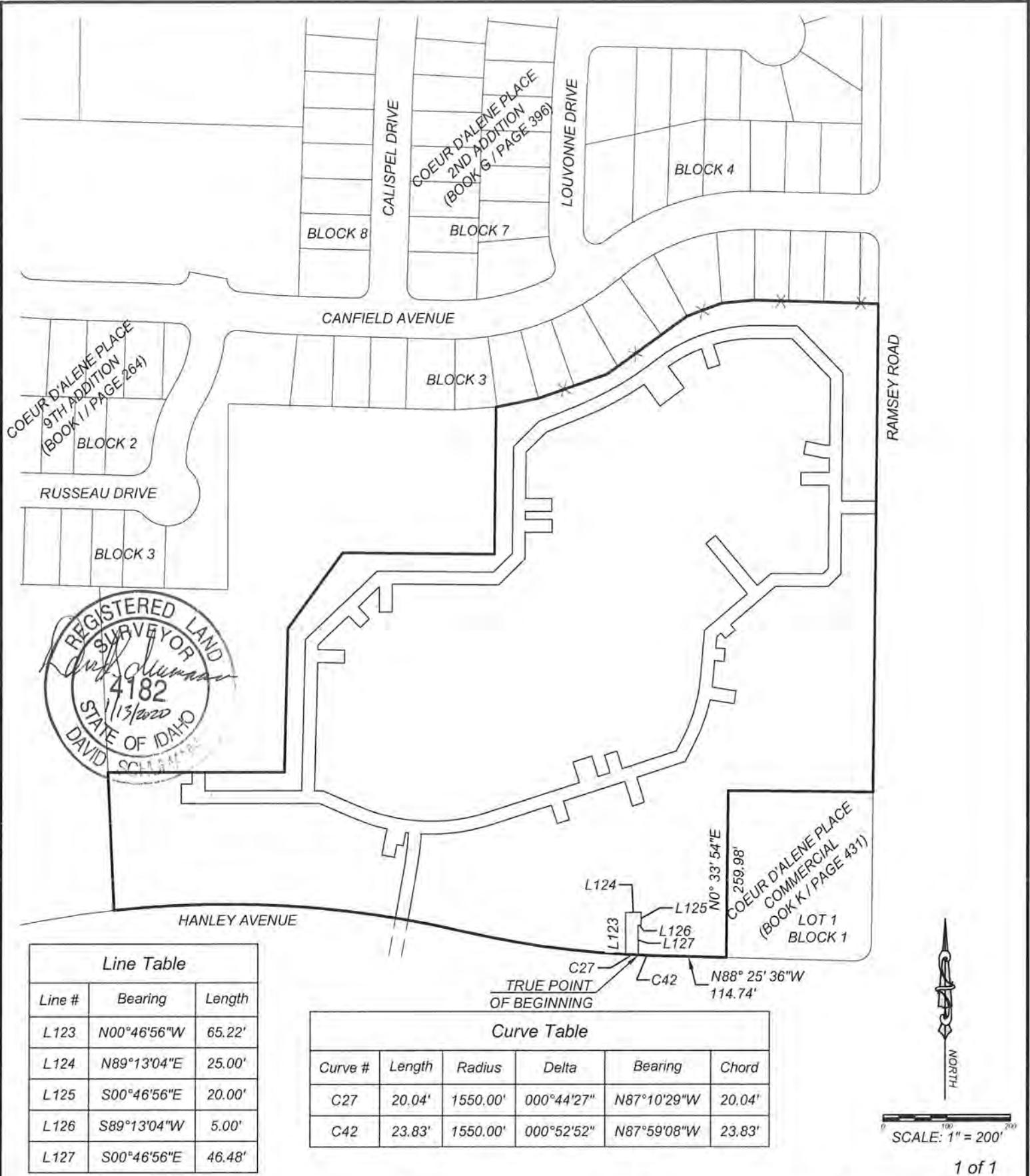

Line Table

Line #	Bearing	Length
L123	N00°46'56"W	65.22'
L124	N89°13'04"E	25.00'
L125	S00°46'56"E	20.00'
L126	S89°13'04"W	5.00'
L127	S00°46'56"E	46.48'

Curve Table

Curve #	Length	Radius	Delta	Bearing	Chord
C27	20.04'	1550.00'	000°44'27"	N87°10'29"W	20.04'
C42	23.83'	1550.00'	000°52'52"	N87°59'08"W	23.83'



SCALE: 1" = 200'



126 E. POPLAR AVENUE
 COEUR D'ALENE, IDAHO 83814
 PHONE: 208.676.0230
 WWW.LAKECITYENGINEERING.COM

Resolution No. 20-005

EXHIBIT D
 WATER EASEMENT

SEC 27, T51N, R4W, B.M.
 CITY OF COEUR D'ALENE, IDAHO

DESIGNED BY:	DHL
DRAFTED BY:	WAL
SCALE:	1" = 200'
DATE:	7/03/2019
JOB NO:	LCE 17-094
FILE:	17-094-WTR-ESMT.dwg

Exhibit "B"

OTHER BUSINESS

**CITY COUNCIL
STAFF REPORT**

DATE: January 21, 2020
FROM: Mike Gridley, City Attorney
SUBJECT: Verizon Small Cell Wireless License Agreement

=====

DECISION POINT:

Should City Council approve a License Agreement (LA) with Verizon Wireless LLC (Verizon) that allows Verizon to use City rights of way (ROW) and poles for the placement of small cell wireless communication equipment?

HISTORY:

State and Federal law allows telecommunication companies to use city owned ROW for the placement of telecommunication equipment, including wireless antennas. Verizon is seeking to upgrade its existing wireless network in Coeur d'Alene with small cell technology. The proposed LA would govern Verizon's use of the City ROW and poles.

FINANCIAL ANALYSIS:

The allowable fees and charges that the City can collect for the placement of wireless communication equipment in its ROW is governed by Federal law. The LA requires Verizon to pay an annual fee of \$270 for each site location on the City ROW. The fee increases 2% every year. In addition, the City is allowed to collect a \$500 site license application fee for up to five site applications.

Verizon is responsible for all installation and maintenance costs except for damage caused by a third-party.

The proposed term of the LA is ten years with two five-year renewal terms if the LA has not been terminated.

PERFORMANCE ANALYSIS:

Verizon will be subject to all City, State and Federal laws, including the City's Wireless Communication Facilities Regulations (MC 17.08.800). This includes the procedure for the processing and approval of the site locations by City staff. ADA compliance and aesthetic considerations such as screening and wrapping of equipment are included in the approval process. Applications will be reviewed by the Planning Department and the Streets & Engineering Department.

The small cell network will improve wireless speed and capacity for customers of Verizon.

DECISION POINT/RECOMMENDATION:

The City Council should approve the LA with Verizon.

Verizon Small Cell Program

January 2020



© 2017 Verizon. This document is the property of Verizon and may not be used, modified or further distributed without Verizon's written permission.

1

What's Happening

94% of people under 40 have a Smartphone

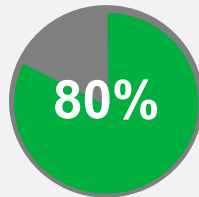

80% of 911 Calls Originate from a cell phone and First responders rely on mobile data

Machine to Machine Connections Increased from 36M in 2013 to 263M in 2018



Digital Equity: lower income families are quicker to depend solely on wireless for data





2

Trends

From 2010 - 2017
Mobile data use \uparrow 39 times

52%+ American Households
Wireless-only

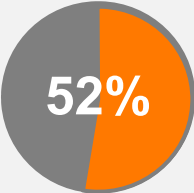
Average American Household:
13 Connected Devices



3





Smart Communities



Smart Health

Public Safety

Smart Transportation



4

The Future Is Bright

Advanced Automation

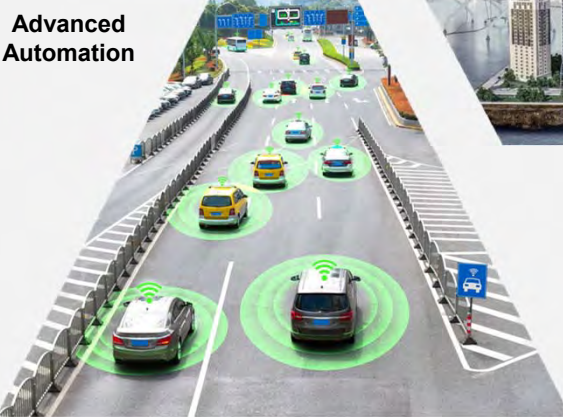

Virtual and Augmented Reality Applications



verizon

5

And So, We Keep Building!

New Macro Cell Sites



Small Cell Technology



In Building and Distributed Antenna Systems

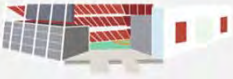

4G & 5G[✓] Ultra Wideband

verizon

6

2018 FCC Order

ROW Use & Pole Attachment:

- Cost based rates
- "Safe Harbor" \$270

Permit Costs:

- \$500 for first 5 sites in application, \$100 for each addition poles
- \$1,000 for new pole application

Application "Shot clocks":

- 60 days for existing pole application
- 90 days for new pole application

Design Standards:

- Reasonable, non-burdensome, published in advance



7

7

Macro Sites vs. Small Cell Sites



© 2017 Verizon. This document is the property of Verizon and may not be used, modified or further distributed without Verizon's written permission.

8

Small vs. Macro Cell – Antenna

Typical Small Cell Antenna

- ~2 ft. in Height
- 1 to 4 per Pole
- Install Height of 20 to 40 ft.
- No Ground Cabinet



Typical Macro Cell Antenna

- 6 or 8 ft. in Height
- 6 to 12 per pole
- Install Height 80 to 200 ft.
- 2 to 4 Large Ground Cabinets or in an Equipment Room



9

Macros and Small Cells Work Together

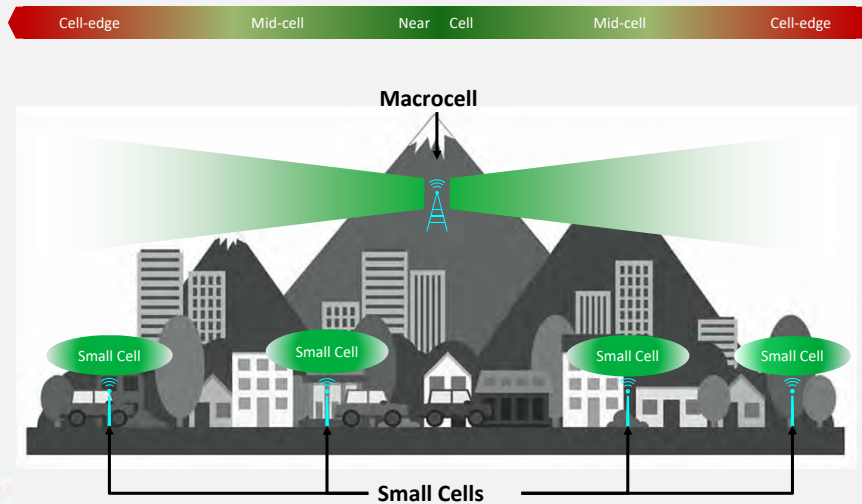

10

Small Cells Are Deployed In Groups Often Called Clusters or Polygons

A Typical Project

- 20-40 Nodes
- Range approximately 200-2,000 feet
- Each node is an individual site
- Spaced so that capacity picks up where it drops off from the adjacent node
- Installation type is determined by the existing ROW infrastructure & Network Needs



Utility Pole



Light Standard



Wireless Only



Strand Mount



11

Radio Frequency Health and Safety



© 2017 Verizon. This document is the property of Verizon and may not be used, modified or further distributed without Verizon's written permission.

12

Radio Frequency Health and Safety

The FCC Sets Standards Based on A Wide Range of Input



Verizon has a comprehensive program to ensure we comply with FCC guidelines

Verizon facilities typically operate at a small fraction of the emission levels set by the FCC

FCC RF Safety:

<http://www.fcc.gov/oet/rfsafety/rf-faqs.html>

<https://www.fcc.gov/engineering-technology/electromagnetic-compatibility-division/radio-frequency-safety/faq/rf-safety#block-menu-block-4>



13

Typical Small Cell RF Levels

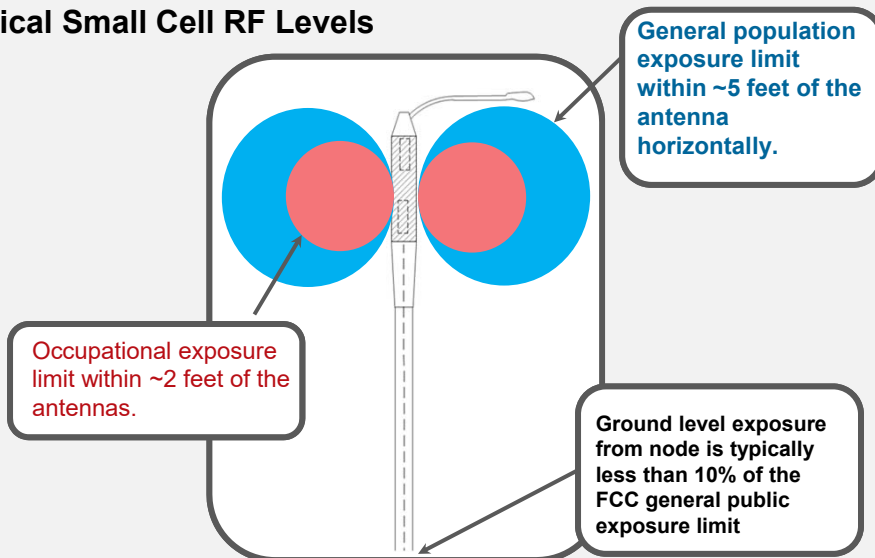

14

Standard Safety Practices

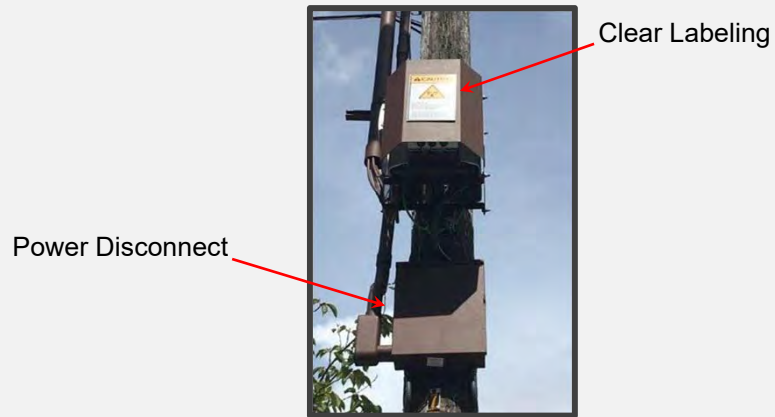

15

What Small Cells Look Like in Boise & Spokane



© 2017 Verizon. This document is the property of Verizon and may not be used, modified or further distributed without Verizon's written permission.

16

Boise



verizon

17

17

Spokane



verizon

18

18

Avista Light Pole Design

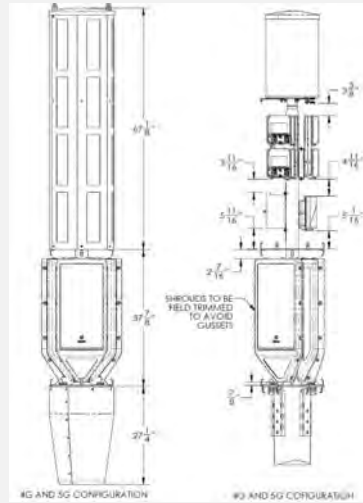

City of Spokane Light Pole Design

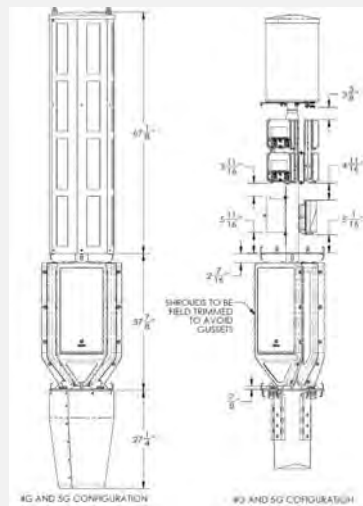

Thank you.



Questions?



RESOLUTION NO. 20-006

A RESOLUTION OF THE CITY OF COEUR D'ALENE, KOOTENAI COUNTY, IDAHO, AUTHORIZING AN AGREEMENT WITH CELLCO PARTNERSHIP d/b/a VERIZON WIRELESS FOR THE USE OF CITY PROPERTY IN CONNECTION WITH THE OPERATION OF A WIRELESS NETWORK.

WHEREAS, it is recommended that the City of Coeur d'Alene enter into an agreement with Cellco Partnership d/b/a Verizon Wireless for the use of City property in connection with the operation of a wireless network, pursuant to terms and conditions set forth in an agreement, a copy of which is attached hereto as Exhibit "1" and by reference made a part hereof; and

WHEREAS, it is deemed to be in the best interests of the City of Coeur d'Alene and the citizens thereof to enter into such agreement;

NOW, THEREFORE,

BE IT RESOLVED by the Mayor and City Council of the City of Coeur d'Alene that the City enter into an agreement with Cellco Partnership d/b/a Verizon Wireless for the use of City property in connection with the operation of a wireless network, in substantially the form attached hereto as Exhibit "1" and incorporated herein by reference with the provision that the Mayor, City Administrator, and City Attorney are hereby authorized to modify said agreement to the extent the substantive provisions of the agreement remain intact.

BE IT FURTHER RESOLVED that the Mayor and City Clerk be and they are hereby authorized to execute such agreement on behalf of the City.

DATED this 21st day of January, 2020.

Steve Widmyer, Mayor

ATTEST:

Renata McLeod, City Clerk

Motion by _____, Seconded by _____, to adopt the foregoing resolution.

ROLL CALL:

COUNCIL MEMBER EVANS Voted _____

COUNCIL MEMBER MCEVERS Voted _____

COUNCIL MEMBER MILLER Voted _____

COUNCIL MEMBER WOOD Voted _____

COUNCIL MEMBER GOOKIN Voted _____

COUNCIL MEMBER ENGLISH Voted _____

_____ was absent. Motion _____.

**AGREEMENT BETWEEN THE CITY OF COEUR D’ALENE, IDAHO AND CELLCO
PARTNERSHIP d/b/a VERIZON WIRELESS FOR THE USE OF LICENSOR
PROPERTY IN CONNECTION WITH THE OPERATION OF A WIRELESS
NETWORK**

This Agreement is made and entered into by and between the City of Coeur d’Alene, Idaho (“Licensor”) and Cellco Partnership d/b/a Verizon Wireless (“Licensee”). Licensor and Licensee may be referred to herein individually as a “Party” or collectively as the “Parties.”

RECITALS

This Agreement is made with reference to the following Recitals, each of which is deemed to be a material term and provision of this Agreement:

A. Licensee desires to construct, operate and maintain communication sites on, over, under, upon, across, or along any public Rights-of-Way within the limits of the City of Coeur d’Alene (“ROW”), as well as locate, place, attach, install, operate, control, and maintain antennas and other related wireless communication equipment consistent with Small Cell technology (“Equipment”) on Licensor-owned poles in the ROW.

B. Licensee will agree to comply with Licensor’s ROW use requirements as provided herein.

C. Licensee is willing to compensate Licensor in exchange for a grant and right to use and physically occupy portions of the poles and/or the ROW as provided herein.

AGREEMENT

1. **Definitions and Exhibits.**

1.1. Definitions. For the purposes of this Agreement and all Exhibits attached hereto, the following terms, phrases, words and derivations shall have the meaning given herein.

(a) *Agreement* means this Master License Agreement for the use of Licensor property in connection with the operation of a wireless network.

(b) *Attachment Fee* or *Pole Attachment Fee* means that fee described in Section 4.1 of this Agreement.

(c) *Application Fee* means the Site Supplement application fee described in Section 4.1 of this Agreement.

(d) *City* means the City of Coeur d’Alene, Idaho.

(e) *Code* means the City Code of Coeur d’Alene.

(f) *Commencement Date* of each Site Supplement is the first day of the month following commencement of installation.

(g) *Equipment* means Small Cell antennas and other wireless communications equipment utilizing small cell technology that is specifically identified and described in Exhibit 1 attached to each Site Supplement (as defined below), which equipment includes but is not limited to (i) equipment attached, mounted, or installed on a pole or poles located within the public ROW, including control boxes, cables, conduit, power sources, and other equipment, structures, and appurtenances, and (ii) all backhaul transmission facilities and utilities necessary to operate the Equipment.

(h) *Hazardous Substance* means any substance, chemical or waste that is identified as hazardous or toxic in any applicable federal, state or local law or regulation, including but not limited to petroleum products and asbestos.

(i) *Interference* means physical interference and radio frequency interference.

(j) *Laws* means any and all applicable statutes, constitutions, ordinances, resolutions, regulations, judicial decisions, rules, permits, approvals or other applicable requirements of the Licensor or other governmental entity or agency having joint or several jurisdiction over Licensee's activities under this Agreement or having jurisdiction that is applicable to any aspect of this Agreement, including the Code (as defined above), that are in force on date of the execution of this Agreement, and as they may be lawfully enacted, issued or amended during the term of this Agreement.

(k) *Losses* mean any and all claims, demands and damages, including attorneys' fees and expenses and costs of defense.

(l) *Permit* means a permit issued and described in accordance with Laws, which is used to regulate, monitor and control improvement, construction or excavation activities, or other work or activity, occurring upon or otherwise affecting the City ROW.

(m) *Physical interference* means where equipment, vegetation or a structure causes reduced use of another's prior mounted equipment, or an obstruction in a necessary line-of-sight path.

(n) *Municipal Facilities* means those Licensor-owned poles and fixtures located within the ROW, including without limitation, streetlight poles but not traffic poles, and such other applicable poles that are the subject of a Site Supplement.

(o) *Radio frequency interference* means the radio frequency energy or signals (or electronic noise) produced by electrical and electronic devices at levels that interfere with the operation of adjacent equipment

(p) *ROW* means the surface of and the space above and below the public roads, streets and alley right-of-way, and public utility easements or other public ways of any type whatsoever, now or hereafter located and existing within the City limits of Coeur d'Alene, Idaho, whether or not improved.

(q) *Site Supplement* means the form of the license granted by this Agreement, described in Section 2 below, and shown on Exhibit A, that governs specific Equipment installations, including any modification or additions thereto made pursuant to Section 2.4, below.

(r) *Small Cell* means compact communication sites in a mobile network but providing a smaller coverage area than traditional macrocells.

(s) *Term* means the period that this Agreement is in effect as described in Section 3.1 of this Agreement.

1.2. Exhibits. The following numbered documents, which are occasionally referred to in this Agreement, are formally incorporated and made part of this Agreement by this reference:

- (a) Exhibit A: Site Supplement (plus attached exhibits).
- (b) Exhibit B: Minimum Limits of Insurance.

In the event of any conflict or ambiguity between this Agreement, including the above-referenced exhibits (the “Exhibits”), and any other agreement between Licensor and Licensee, this Agreement, together with the Exhibits, shall govern and prevail. In the event of any conflict or ambiguity between this Agreement, including the Exhibits, and any Site Supplement, the Supplement shall govern and prevail unless otherwise agreed by the Parties in writing. In the event of any conflict or ambiguity between this Agreement, and the Code, this Agreement shall govern and prevail.

2. Site Supplement Granted and Terms.

2.1. Scope. Licensor, acting in its capacity as the owner of Municipal Facilities in the ROW, does grant to Licensee a nonexclusive, revocable license to use the ROW and Municipal Facilities identified in Exhibit 1 to each Site Supplement to attach, install, operate, maintain, upgrade, remove, reattach, reinstall, relocate and replace the Equipment that may be required or desired to operate a Small Cell (the “Site Supplement”). This grant is subject to the terms, conditions and other provisions set forth in this Agreement; to applicable provisions of the Code; applicable required permits; and all applicable Laws and reasonable regulations of any regulatory agency having competent jurisdiction. This Agreement is not intended to, and shall not, preclude or impede the ability of Licensor to enter into other similar agreements in the future allowing third parties to also use the ROW, or the ability of Licensor to redesign, reconstruct, relocate, maintain and improve its ROW as it determines in its sole discretion is appropriate in accordance with applicable law, and subject to the terms herein.

2.2. Use of Licensor Property. The Site Supplement, if and when approved by Licensor, allows Licensee to access, occupy and use the ROW and allocated available space on each of the poles identified as Municipal Facilities in Exhibit 1 to the Site Supplement to attach, install, operate, maintain, upgrade, remove, reattach, reinstall, relocate and replace the Equipment, as identified in such Exhibit 1, solely for the purpose of Licensee operating a Small Cell. The Site Supplement also allows the installation, operation and maintenance of ground based, pad mounted

equipment cabinets and/or power pedestals needed for the operation of Equipment attached to any of the Municipal Facilities, together with any related conduit, cable or wiring, with the location of any such cabinet or pedestal determined in connection with the issuance of a Permit. Licensee shall have access to the Municipal Facilities upon which Equipment is installed 24 hours a day, 7 days a week, subject to all limitations and other provisions of this Agreement. Within sixty (60) days of receipt of a draft Site Supplement (“Site Supplement Application”), which period may be extended by mutual written consent, the Licensor shall, in writing, sign the Site Supplement Application, or reject the Site Supplement Application by identifying the specific reasons why the Site Supplement Application is not in compliance with this Agreement or the Code. If the Licensor timely rejects the Site Supplement Application, the review period will be suspended until such time that Licensee cures the non-compliance. The Licensor may also toll the time period for approval of the Site Supplement Application on a day-by-day basis upon a reasonable request for additional information. If the Site Supplement Application is complete and in compliance with applicable city, state and federal requirements, and is deemed acceptable by both Parties, the Parties shall execute the Site Supplement, which shall be effective as of the date of full execution.

2.3. Limitations on Use. Except as otherwise expressly provided herein, the Site Supplement does not authorize Licensee to:

(a) Occupy or use any poles, improvements or structures of any kind, whether within or without the ROW, other than the items identified as Municipal Facilities shown in Exhibit 1 attached to a Site Supplement;

(b) Subject to Section 2.5 below, enter upon public property and attach, install, operate, maintain, upgrade, remove, reattach, reinstall, relocate, and/or replace any item of Equipment in or on poles or other structures not owned by Licensor and located within the ROW, unless granted the right to do so pursuant to a separate agreement with the third party;

(c) Occupy or use the ROW to the exclusion of Licensor for any use within Licensor’s jurisdiction, authority and discretion or of others to the extent authorized by law to use the ROW;

(d) Interfere with the rights of holders of easements of record on inspection of the ROW and statutory rights of utilities to use the public ROW contrary to applicable Law; or

(e) Take any action that would jeopardize the structural integrity of Licensor’s Municipal Facilities, conflict with Licensor’s operations, or interfere with the public’s access or use of the ROW.

2.4. Alterations. If Licensee proposes to install Equipment which is different in any material way from the then-existing and approved Equipment, then Licensee shall first obtain the written approval for the use and installation of the unauthorized Equipment from an authorized representative of the Licensor, which approval shall be in writing. In addition to any other submittal requirements, and if requested by Licensor, Licensee shall provide “load” (structural) calculations for all Municipal Facilities upon which it intends to modify Equipment in the ROW. Notwithstanding the foregoing, Licensee may modify its Equipment with like-kind or similar Equipment of the same color, type and design without prior written approval of the Licensor, so

long as it (i) does not differ in any material way from the then-existing and approved Equipment and (ii) does not jeopardize the structural integrity of Licensor's Municipal Facilities or interfere with Licensor's operations and (iii) does not interfere with the public's access or use of the ROW.

2.5. Additional Installations. Subject to obtaining the written permission of the owner(s) of the affected property and any required Permits (and paying any standard fees), the Licensor hereby authorizes and permits Licensee to enter upon the ROW and to attach, install, operate, maintain, remove, reattach, reinstall, relocate, and replace Equipment in or on poles or other structures lawfully owned and operated by public utility companies or other property owners located within or outside the ROW as may be permitted by the public utility company or property owner, as the case may be. In such situation, a Site Supplement shall not be required nor shall a Pole Attachment Fee be paid to the City; provided, however, Licensor may require Licensee to furnish to the Licensor documentation of such permission from the individual utility or property owner responsible upon Licensor's request. Nothing herein is intended to limit any rights Licensee may have in accordance with Laws or the Code to install its own poles in the ROW.

3. Term of Supplements and Agreement; Cancellation; Termination; Removal or Abandonment.

3.1. Agreement Term. This Agreement shall be in effect for a period of ten (10) years commencing on the date that this Agreement is fully executed (the "Execution Date"). and expiring on the later of (a) the tenth (10th) anniversary of the Execution Date, or (b) the expiration of the last Supplement Term (unless sooner cancelled or terminated as provided in this section) (the "Term"). Unless either Party provides written notice to the other Party at least ninety (90) days prior to expiration of the Term that it does not intend to renew the Agreement, the Term will automatically renew for two (2) additional five (5) year periods.

3.2. Supplement Term. Each Site Supplement shall be in effect for a period of ten (10) years commencing on the "Commencement Date" determined in accordance with each Site Supplement, and expiring on the day before the tenth (10th) anniversary of the Commencement Date, unless sooner cancelled or terminated as provided herein (the "Supplement Term"). Provided that Licensee is not in material breach of the Site Supplement or this Agreement, and that this Agreement has not been terminated, the Supplement Term will automatically be extended for two five (5) year periods (each a "Renewal Term") All of the provisions of this Agreement shall be in effect during the Supplement Term.

3.3. Licensor Termination. This Agreement and all Site Supplements may only be cancelled or terminated as provided in this Agreement or any Site Supplement. Licensor may immediately terminate this Agreement or any Site Supplement in the event of an uncured default upon written notice to Licensee. In addition, Licensor may terminate a specific Site Supplement, with or without cause, upon twelve (12) months' notice to Licensee. Notwithstanding the foregoing, Licensor will exercise reasonable efforts to avoid terminating any Site Supplement so long as Licensee agrees to relocate the Equipment to an acceptable location approved by Licensor and documented in a new or amended Site Supplement. If (i) within sixty (60) days after Licensee receives notice of termination, Licensor and Licensee establish a mutually agreeable alternative location for Licensee's Equipment, and (ii) Licensee relocates its

equipment within one hundred eighty (180) days after establishing such alternate location (which period of time may be extended by the Parties in writing), then the notice of termination shall be of no further force and effect and the applicable Site Supplement shall continue and govern the Equipment at the new location.

3.4. Licensee Cancellation. Licensee may cancel this Agreement or any Site Supplement before the date of expiration by providing the Licensor with one hundred eighty (180) days' express written notice of cancellation. Any prepaid Pole Attachment Fee shall be retained by Licensor, and Licensee shall remove its Facilities and Equipment within ninety (90) days after the date of such termination.

3.5. Abandonment. If Licensee abandons the use of a Municipal Facilities location for a period of six (6) or more consecutive months, the Equipment for such Municipal Facilities shall be removed at the expense of Licensee, and the Site Supplement to the extent of such removed equipment shall be considered terminated. In the event Licensee is unable or refuses to remove such Equipment within the time period requested by Licensor, Licensor may authorize removal and Licensee shall be responsible for all costs incurred for such removal. Alternatively, Licensor may elect to take title to abandoned property, provided that Licensee shall submit to Licensor at Licensee's expense an instrument satisfactory to Licensor transferring to Licensor the ownership of such property. The provisions of this Section shall survive the expiration or earlier termination of this Agreement.

3.6. Licensee Termination. Licensee's use is contingent upon Licensee obtaining all certificates, permits and other approvals that may be required by any federal, state or local authority as well as a satisfactory structural analysis of any buildings, light poles, signs or other structure that will permit Licensee's use. The governmental approvals shall be a condition precedent to Licensee's signature of a Site Supplement. Licensee may terminate this Agreement or the affected Site Supplement should Licensee be unable to secure or maintain any required governmental approval.

4. Fees and Charges. Licensee shall be solely responsible for the payment of all fees and charges in connection with Licensee's performance under this Agreement, including those set forth as follows:

4.1. Annual Attachment Fees; Application Fee. As of the Commencement Date for each Site Supplement, Licensee shall pay to Licensor an annual fee equal to Two Hundred Seventy and 00/100 Dollars (\$270.00) for the use of each Municipal Facility by Licensee pursuant to a Site Supplement, in order for Licensee to occupy and use space on the Municipal Facilities. The annual fee paid per site location is non-refundable and is due and payable within forty-five (45) days after the initial Commencement Date for each Site Supplement, and on or before each subsequent annual anniversary of the Commencement Date during the Supplement Term (or until such earlier time as such Site Supplement is terminated). Upon agreement of the Parties, Licensee may pay the Attachment Fee by electronic funds transfer and in such event, Licensor agrees to provide to Licensee bank routing information for such purpose upon request of Licensee. Additionally, Licensee will pay Licensor a Site License Application Fee in the amount of Five Hundred and 00/100 Dollars (\$500.00) for up to five applications, and One Hundred and 00/100 Dollars for each application beyond five. The Application will include engineering drawings and a structural analysis stamped by a licensed professional engineer along

with Facility site elevations. Licensor will respond to Licensee concerning each Site Supplement Application as required by and in accordance with the timelines set forth in applicable Law. For any party to whom rental payments are to be made, Licensor or any successor in interest of Licensor hereby agrees to provide to Licensee (i) a completed, current version of Internal Revenue Service Form W-9, or equivalent; and (ii) complete and fully executed state and local withholding forms if required. Rental shall accrue in accordance with this Agreement, but Licensee shall have no obligation to deliver rental payments until the requested documentation has been received by Licensee. Upon receipt of the requested documentation, Licensee shall deliver the accrued rental payments as directed by Licensor.

Effective on the first anniversary of the Commencement Date of any Supplement License Term, and on each anniversary thereafter during the applicable Supplement License Term, the applicable annual fee shall be increased by two percent (2%) over the annual fee paid for the immediately preceding year.

4.2. Permit. No payment is collected under this Agreement for any Permit issued in connection with the installation of Equipment at any Municipal Facility. Permit requirements, fees and charges are solely governed by the requirements imposed by the Code and City policy and shall be paid by Licensee accordingly. Fees and charges for any such Permit usually are collected at the time such a permit is applied for and issued.

4.3. Taxes. Licensee shall pay all applicable city, county and state taxes levied, assessed, or imposed by reason of this Agreement or those related to any of Licensee's Equipment and/or provided services.

4.4. Electric meter. Licensee shall install or cause to be installed at Licensee's cost a separate electric meter on a ground mounted pedestal or on Licensee's pad mounted equipment cabinet as required by the electric provider for the operation of its Equipment. Licensee's electric meter shall not, under any circumstances, interfere with Licensor's operations. Licensee shall be responsible for paying all charges for any electricity furnished by a utility company furnishing service to the Equipment.

4.5. Payments Made. All fees and/or additional payments shall be payable to Licensor at: City of Coeur d'Alene, Attn: Finance Department, 710 E. Mullan Avenue, Coeur d'Alene, ID 83814; or via electronic transfer to Licensor; or to such other persons or at such other places as Licensor may designate in writing.

4.6. Interest. In the event of default by Licensee on any payment owed pursuant to this Agreement or any Site Supplement, the unpaid sum shall bear interest from the date the same became due at the rate of ten percent (10%) per annum or at the highest rate permitted under the laws of the State of Idaho, whichever is the higher.

5. Additional Requirements of the City Code. All of the Equipment will be installed, operated and maintained by or on behalf of Licensee in accordance with applicable provisions of the Code regulating wireless communications facilities. Licensee or its designee shall be required to apply for and obtain a Permit issued by the Licensor for work performed within the ROW, and the ROW will be used according to the plans submitted by Licensee and approved by the Licensor in issuing a Permit. Notwithstanding the foregoing, Licensee's operation of the

Equipment and the work performed in the ROW shall not, under any circumstances, interfere with Licensor's operations of the public use of the ROW. Execution of this Agreement or any Site Supplement does not constitute the issuance of a Permit. In the event of any discrepancy between the terms of this Agreement and a Permit, the terms of this Agreement shall control.

6. **Basic Design and Installation Requirements for Using Municipal Facilities.** The basic design of the Equipment will be described in Exhibit 1 to each Site Supplement. All of Licensee's construction and installation work for its Equipment on the Municipal Facilities shall be performed at Licensee's sole cost and expense and in a good and workmanlike manner and promptly completed. When Licensee and Licensor have agreed on an existing Municipal Facility location as a suitable site for Licensee's Equipment, but the existing Licensor-owned pole needs to be replaced to accommodate the Equipment, then Licensee shall pay all costs related to replacing the Licensor-owned pole, including but not limited to installation of the replacement pole (the "Replacement Pole"), transfer of the streetlight fixtures, and/or other items attached to the existing Licensor-owned pole to the Replacement Pole, and removal and salvage of the existing Licensor-owned pole. Payment of the pole replacement costs does not provide Licensee with any ownership interest in the Replacement Pole. Licensor will be deemed to own the original Licensor-owned pole and the Replacement Pole. The installation or attachment of the Equipment using the Replacement Pole shall be at Licensee's sole cost and expense.

7. **Common Conditions or Requirements Applicable to Site Supplements Issued Under this Agreement.**

7.1. **Equipment Locations.** For each installation, Licensee or its designee shall submit plans and specifications for Licensor review and approval. Locations should be prioritized based upon Licensee's technical and radio frequency needs and construction costs. In addition, in any situation where Licensee has a choice of attaching its equipment to either Municipal Facilities or third-party-owned property in the ROW, Licensee shall use good faith efforts to attach to the Municipal Facilities provided that (a) such Municipal Facilities are at least equally suitable functionally for the operation of Licensee's network, and (b) the construction and installation costs associated with such attachments over the length of the term are equal to or less than the cost to Licensee of attaching to the alternative third-party-owned property. In the event that no suitable Municipal Facilities or third-party-owned poles are functionally suitable, Licensee may at its sole cost and expense install its own poles. Design, location and height of proposed Licensee poles shall be reviewed and are subject to written approval by Licensor prior to installation. Licensee's equipment and poles must conform as closely as practicable with the design and color of poles existing in the vicinity of Licensee's Equipment or pole location. Subject to the terms and conditions of this Agreement and the applicable Supplement, Licensee will be responsible for all maintenance, repair and liability for all poles installed by Licensee in the ROW for Licensee's use. Such obligation shall not extend to any Replacement Pole installed pursuant to Section 7.4, or other pole owned by the Licensor. Upon Licensor approval, the approved plans are inserted in Exhibit 1 attached to a Site Supplement. If Licensee desires to change or add new locations, Licensee will submit a proposed Site Supplement indicating the additional Municipal Facilities that it wishes to use.

7.2. **Damage to Licensor Property.** If Licensee damages or disturbs the surface or subsurface of any ROW or adjoining property, pole, streetlight fixture or other public improvement, in the exercise of the rights granted through this Agreement, Licensee will

promptly, at its own expense, and in a manner acceptable to Licensor, in Licensor's sole discretion, repair the damage or disturbance within thirty (30) days after receipt of notice.

7.3. Public Emergency. In the event of an emergency or to protect the public health or safety, prior to the Licensor accessing or performing any work on a Municipal Facility on which Licensee has installed Equipment, Licensor may require Licensee to deactivate such Equipment if any of Licensor's employees or agents must move closer to the Equipment than the FCC recommended minimum distance. In such case, Licensor will contact Licensee at 800-264-6620 to request immediate deactivation.

7.4. Pole Replacement.

(a) Licensee hereby acknowledges that Licensee shall bear all risk of loss in connection with: (i) damaged Municipal Facilities and Equipment to the extent such damage is caused by Licensee; (ii) the performance by Licensee of maintenance and repair required under this Agreement or the failure or neglect to perform such maintenance and repair; and/or (iii) repair or maintenance necessitated by Licensee's design, installation or use of the Equipment. If a Municipal Facility needs replacement or repair in order to hold Equipment due to the occurrence of any or a combination of causes (i), (ii) and (iii) above, Licensee shall replace the same at Licensee's cost within a timeframe reasonably determined by Licensor and upon Licensor's approval.

(b) Subject to Section 7.4(g), if a Municipal Facility needs replacement or repair due to a traffic accident or deterioration, Licensee shall have the right to immediately replace the same at Licensor's cost. In such event, Licensor shall reimburse Licensee within thirty (30) days of Licensor's receipt of an invoice. However, in the event Licensee elects in writing to have Licensor replace the Municipal Facility, Licensor shall perform such replacement within thirty (30) days thereafter, and Licensee shall cooperate with Licensor to temporarily relocate its Equipment, if necessary. Upon completion of the replacement, Licensor shall notify Licensee in order for Licensee to install its Equipment.

(c) At Licensee's option, Licensee may provide to Licensor, at Licensee's cost, a spare pole sufficient to serve as a replacement pole, which will be stored at Licensor's Public Works location (the "Yard") at no cost to Licensee, and which will be available for use by Licensor and Licensee to replace the Municipal Facility as provided in this Section 7.4.

(d) In the event Licensee provides a spare pole, and in lieu of Licensee performing the replacement, Licensor will use the spare pole to replace the damaged existing pole within twenty-four (24) hours of the need for the replacement, and shall deliver the damaged pole and any damaged equipment to the Yard.

(e) Licensor will contact Licensee to pick up the damaged equipment and Licensee may reinstall its equipment once the replacement pole is installed and functioning as a Municipal Facility and acknowledged by Licensor in writing.

(f) Licensee shall have the right to temporarily use a Municipal Facility for its operation during the replacement period at a location reasonably acceptable to both Licensor and Licensee.

(g) In the event Licensor is responsible for replacing the Municipal Facility with a Replacement Pole, Licensor shall only be responsible for the cost of a standard pole, and Licensee shall be responsible for the cost of the Replacement Pole in excess of the cost of a standard pole. If Licensor is responsible for replacing a Municipal Facility, it shall pay for a basic Municipal Facility and Licensee shall pay for any extra costs to customize the Municipal Facility to Licensee's specifications.

7.5. Removal and Relocation.

(a) Licensee understands and acknowledges that Licensor may require Licensee to relocate one or more of its Equipment installations if necessary, for public use. Licensee shall, at Licensor's direction and upon one hundred twenty (120) days prior written notice to Licensee, relocate such Equipment at Licensee's sole cost and expense whenever Licensor reasonably determines that the relocation is needed (i) if required for the construction, modification, completion, repair, relocation, or maintenance of a Licensor or other public agency project; (ii) because the Equipment is interfering with or adversely affecting proper operation of Licensor-owned Poles, traffic signals, communications, or other Municipal Facilities; or (iii) Licensor is abandoning or removing the Municipal Facility. In any such case, Licensor shall use reasonable efforts to afford Licensee a reasonably equivalent alternate location. If Licensee shall fail to relocate any Equipment as requested by the Licensor in accordance with the foregoing provision, Licensor (i) may treat such failure as a default under Section 16, or (ii) Licensor shall be entitled to remove or relocate the Equipment at Licensee's sole cost and expense, without further notice to Licensee. Licensee shall pay to the Licensor actual costs and expenses incurred by the Licensor in performing any removal or relocation work and any storage of Licensee's property after removal within thirty (30) days of the date of a written demand for this payment from the Licensor.

(b) In the event Licensee desires to relocate any Equipment from one Municipal Facility to another, Licensee shall so advise Licensor. Licensor may at Licensor's option, use reasonable efforts to accommodate Licensee, at Licensee's cost, by making another reasonably equivalent Municipal Facility available for use in accordance with and subject to the terms and conditions of this Agreement.

(c) In lieu of the relocation of Licensee's Equipment in the case of an abandonment or removal of a Municipal Facility as provided in Section 7.5(a), unless the Municipal Facility is needed for a legitimate Licensor purpose, Licensee shall have right to purchase the Municipal Facility, and continue to use the same pursuant to the then existing Site Supplement, at a commercially reasonable price commensurate with its then existing value. Licensee and Licensor shall document such transfer of ownership via a commercially reasonable bill of sale.

7.6. Compliance with Law Required. The work done by Licensee in connection with the installation, construction, maintenance, repair and operation of Equipment on Poles within the ROW shall be subject to and governed by all pertinent laws, including the Licensor's ROW regulations that are applicable to ensuring that the work done does not create a public nuisance, or obstruct the use of the surface of the streets and sidewalks.

7.7. Identification of Utility Lines. Prior to beginning any excavation of boring projects in the ROW, Licensee shall engage a utility locator service. Licensee has the responsibility to protect and support the various utility facilities of other providers while conducting construction, installation and maintenance operations.

7.8 Submission of Engineering Plans. In conformance with this Agreement, and prior to installation, Licensee shall submit engineering plans to the Streets & Engineering Department for review and approval in accordance with the Rights-of-Way Regulations.

7.9. Non-exclusiveness. The rights and privileges granted to Licensee under this Agreement, and each Site Supplement described herein, are non-exclusive.

7.10. Non-interference. The following provisions shall apply to ensure and/or avoid interference (both physical interference and radio frequency interference) resulting from Licensee's installation, operation and/or maintenance of its Equipment:

(a) RF Interference. Licensee shall ensure that the Equipment will not cause radio frequency interference with wireless communication facilities or devices of third parties existing at the time of installation of the Equipment, or with cable television, broadcast radio or television systems, satellite broadcast systems, traffic signals, public access or safety or other communications signal equipment.

(b) Existing Uses. Licensee shall not interfere in any manner with the uses of Licensor property including ROW, and including, but not limited to, sanitary sewers, fiber optics, water mains, storm drains, gas mains, poles, aerial and underground electric and telephone wires, streetlight fixtures, cable television, and utility and municipal property without the express written approval of the owner(s) of the affected property or properties.

(c) Licensee shall not interfere in any manner with current or future traffic safety equipment or signals or communications of Licensor.

(d) Harmful Interference. Licensor reserves the right, but not the obligation, to maintain and operate its Municipal Facilities in such manner as will best enable Licensor to fulfill its own service requirements or obligations. However, Licensor agrees that Licensor and/or any other tenants, licensees, or users of the ROW who currently have or in the future take possession of space within the ROW will be permitted to install only such equipment that is of the type and frequency which will not cause harmful interference which is measurable in accordance with then existing industry standards to the then existing Equipment of Licensee, but only to the extent Licensee has provided Licensor with written notice of any such equipment that could cause or is causing such harm in accordance with established industry standards and applicable law.

(e) Remedies. Without limiting any other rights or remedies, if interference occurs and continues for a period in excess of twenty-four (24) hours following notice to the Licensee via telephone to Licensee's Network Operations Center at (800) 621-2622, or to Licensor at (208) 769-2231, then the interfering party shall reduce power or cease operations of the interfering equipment until the interference is cured. The Parties acknowledge that there will not be an adequate remedy at law for noncompliance with the provisions of this Section 7 and

therefore the Parties shall have the right to equitable remedies such as, without limitation, injunctive relief and specific performance.

8. **Damage to Licensee's Equipment.** In the event of any damage to Licensee's Equipment, Licensor shall have no liability or responsibility to repair the same unless such damage arose from the negligence or willful misconduct of Licensor, its employees, agents, or contractors; provided, however, in such case, Licensor's liability shall be limited to the cost to repair or replace the same.

9. **Title and Ownership.**

9.1. **Title to the Municipal Facility.** Title to the Municipal Facilities shall remain with Licensor. Subject to the terms of abandonment as provided hereunder, title to the Equipment, exclusive of the Municipal Facilities (original or replacement) including ground mounted equipment, shall remain with Licensee and shall constitute Licensee's personal property and equipment, and not fixtures or improvements attached to the land.

9.2. **No Ownership in Licensor Property.** Neither this Agreement, nor any license issued herein, nor any Permit separately issued for installation of any Equipment, regardless of the payment of any fees and charges, shall create or vest in Licensee any ownership or property rights in any portion or elements of the Municipal Facilities, the underlying real property on which any Licensor-owned poles or any Equipment is located, or any portion of the ROW. Licensee acknowledges that this Agreement does not constitute or create a leasehold interest or right to the benefit of any Licensor property or portion thereof. Nothing contained in this Agreement shall be construed to compel Licensee to construct, retain, extend, place, or maintain any poles or other facilities for the benefit of Licensor which are not needed for Licensee's own service requirements.

9.3. **"As Is" Condition.** Licensee accepts the Municipal Facilities identified in any Site Supplement, or any Replacement Pole, in its "AS IS" condition, without representation or warranty of any kind by Licensor, or any Licensor officer, agent, or employee, and subject to all applicable laws, rules and ordinances governing the use of the Licensor poles or of Licensor for Licensee's intended purpose.

10. **Permissive Use.** Licensee acknowledges and agrees that the license granted under this Agreement is a permissive use of the ROW pursuant to this Agreement. Licensee further acknowledges and agrees that Licensee is solely responsible for obtaining the approval of any local land use agencies with jurisdiction over Licensee's use of the ROW.

11. **Maintenance and Repair.** Subject to Section 7, Licensor shall maintain and keep the Municipal Facility containing Equipment in accordance with Licensor's standard maintenance requirements, at its sole cost and expense. Licensee shall keep the Equipment and other improvements by Licensee on the Municipal Facility, if any, in good repair.

12. **Hazardous Substances.** Licensee agrees that Licensee, its contractors, subcontractors and agents, will not use, generate, store, produce, transport or dispose any Hazardous Substance on, under, about or within the area of a Municipal Facility or the ROW in which it is located in violation of any applicable federal, state, county, or local law or regulation. Except to the extent of the negligence or intentional misconduct of Licensor, Licensee will pay, indemnify, defend and hold

Licensor harmless against and to the extent of any loss, damage, cost, expense, attorneys' fees or liability incurred by reason of any Hazardous Substance produced, disposed of, or used by Licensee pursuant to this Agreement. Licensee will ensure that any on-site or off-site storage, treatment, transportation, disposal or other handling of any Hazardous Substance will be performed by persons who are properly trained, authorized, licensed and otherwise permitted to perform those services. The Parties recognize that Licensee is only using a small portion of the ROW and that Licensee shall not be responsible for any environmental condition or issue except to the extent resulting from Licensee's specific activities and responsibilities under this Agreement.

13. **Waiver and Indemnity.**

13.1. **Waiver of Claims.** Licensee waives any and all claims, demands, causes of action and rights it may assert against the Licensor on account of any loss, damage, or injury to any Equipment as a result of any event or occurrence which is beyond the reasonable control of Licensor.

13.2. **Fire Insurance.** If damages to the Municipal Facilities or ROW results from any fire, or other casualty of the kind covered by standard fire insurance policies of Licensee with extended coverage, except to the extent caused by the negligence or willful misconduct of Licensor, its employees, agents, or contractors, then Licensee shall be responsible for all damages to Licensee's Equipment, the Municipal Facilities and the ROW. Licensor is not responsible for maintaining any separate policy for fire coverage related to Licensee's use of its Equipment in the ROW.

13.3 **Indemnity.** To the extent permitted by law, each Party shall indemnify, defend, and hold the other harmless against any claim of liability or loss from personal injury or property damage resulting from or arising out of the negligence or willful misconduct of the indemnifying Party, its employees, contractors or agents, except to the extent such claims or damages may be due to or caused by the negligence or willful misconduct of the other Party, or its employees, contractors or agents. In addition, Licensee shall indemnify, defend, and hold Licensor harmless against any claim of liability or loss from personal injury or property damage to the extent resulting from the installation and use of Licensee's Equipment, except to the extent such claims are caused by or resulting from the negligence or willful misconduct of Licensor, its employees, agents, or contractors. The indemnified Party will provide the indemnifying Party with prompt, written notice of any claim covered by this indemnification; provided that any failure of the indemnified Party to provide any such notice, or to provide it promptly, shall not relieve the indemnifying Party from its indemnification obligation in respect of such claim, except to the extent the indemnifying Party can establish actual prejudice and direct damages as a result thereof. The indemnified Party will cooperate appropriately with the indemnifying Party in connection with the indemnifying Party's defense of such claim. The indemnifying Party shall defend any indemnified Party, at the indemnified Party's request, against any claim with counsel reasonably satisfactory to the indemnified Party. The indemnifying Party shall not settle or compromise any such claim or consent to the entry of any judgment without the prior written consent of each indemnified Party and without the unconditional release of all claims by each claimant or plaintiff in favor of each indemnified Party.

14. **Insurance Requirements.**

14.1. **Licensee's Insurance.** Licensee shall procure and maintain insurance in the amounts and form specified in attached Exhibit B.

14.2. Certificates. If a Certificate of Insurance or Self-Insurance is submitted as verification of coverage, Licensor will reasonably rely upon the Certificate as evidence of coverage but this acceptance and reliance will not waive or alter in any way the insurance requirements or obligations of this Agreement. If any of the required policies expire during the life of this Agreement, Licensee must forward renewal or replacement Certificates to Licensor within fifteen (15) business days before the expiration date containing all the necessary insurance provisions.

15. Assignment.

15.1. This Agreement and each license granted herein is personal to Licensee and for Licensee's use only. Licensee shall not lease, assign, sublicense, share with, convey or resell to others any such space or rights granted hereunder. Subject to Section 15.3, this Agreement and the related rights and privileges may not be assigned or otherwise transferred without the express written consent of Licensor, which consent shall not be unreasonably withheld, conditioned or delayed. Any Agreement which is assigned or otherwise transferred pursuant to this Section shall be equally subject to all the obligations and privileges of this Agreement including any amendments, which will remain in effect, as if the assigned Agreement was the original Agreement. After assignment, this Agreement, including any amendments, shall be binding on the assignee to the full extent that it was binding upon Licensee.

15.2. Any non-permitted transfer or assignment of the right to attach Equipment to a Licensor-owned pole shall be void and not merely voidable. Licensor may, in its sole discretion and in addition to all other lawful remedies available to Licensor under this Agreement, collect any fees owed from Licensee, all without prejudicing any other right or remedy of Licensor under this Agreement. No cure or grace periods shall apply to transfers or assignment prohibited by this Agreement or to the enforcement of any provisions of this Agreement against a transferee or assignee who did not receive Licensor's consent.

15.3. Notwithstanding anything to the contrary in this Section 15, without any approval or consent of Licensor, this Agreement and/or any Site Supplement may be sold, assigned or transferred by Licensee to (i) any entity in which Licensee directly or indirectly holds an equity or similar interest; (ii) any entity which directly or indirectly holds an equity or similar interest in Licensee; or (iii) any entity directly or indirectly under common control with Licensee. Licensee may assign this Agreement and/or any Site Supplement to any entity which acquires all or substantially all of Licensee's assets in the market defined by the FCC in which the Municipal Facility is located by reason of a merger, acquisition or other business reorganization without approval or consent of Licensor.

16. Default. It is a "Default" if (i) either Party fails to comply with this Agreement or any Site Supplement and does not remedy the failure within thirty (30) days after written notice by the other Party or, if the failure cannot reasonably be remedied in such time, if the defaulting Party does not commence a remedy within the allotted thirty (30) days and diligently pursue the cure to completion within sixty (60) days after the initial written notice, or (ii) Licensor fails to comply with this Agreement or any Site Supplement and the failure interferes with Licensee's use of its Equipment and Licensor does not remedy the failure within fifteen (15) days after written notice from Licensee or, if the failure cannot reasonably be remedied in such time, if

Licensor does not commence a remedy within the allotted fifteen (15) days and diligently pursue the cure to completion within thirty (30) days after the initial written notice.

17. **Termination.** In the event of a Default, without limiting the non-defaulting party in the exercise of any right or remedy which the non-defaulting party may have by reason of such Default, the non-defaulting Party may terminate this Agreement if the Default affects all Site Supplements and the Agreement as a whole, or any Site Supplement subject to the Default, and/or pursue any remedy now or hereafter available to the non-defaulting Party under the laws or judicial decisions of the State of Idaho. Further, upon a Default, the non-defaulting Party may at its option (but without obligation to do so), perform the defaulting Party's duty or obligation. The costs and expenses of any such performance by the non-defaulting Party shall be due and payable by the defaulting Party upon invoice therefor. If Licensee undertakes any such performance on Licensor's behalf and Licensor does not pay Licensee the full undisputed amount within thirty (30) days of its receipt of an invoice setting forth the amount due, Licensee may offset the full undisputed amount due against all fees due and owing to Licensor under this Agreement until the full undisputed amount is fully reimbursed to Licensee.

18. **Records.** Licensee will maintain complete records pursuant to applicable federal, state and local laws and regulations. Upon reasonable request by Licensor and within thirty (30) days' notice to Licensee, Licensee will provide Licensor with a report, but no more frequently than once a year, that includes at least the following information: (i) a list of all Site Supplements, (ii) the location of all of Licensee's Equipment, and (iii) a summary of all annual fees and application fees and any other amounts paid by Licensee or due and owing to Licensor to date.

19. **Removal.** Within ninety (90) days of the expiration of the Term of any Site Supplement, or upon the earlier termination thereof, Licensee shall remove all Equipment attached or ground mounted, at its sole expense, shall repair any damage to the Municipal Facilities or the ROW caused by such removal, and shall restore the Municipal Facilities and ROW to the condition in which they existed prior to the installation of the Equipment (whether attached or ground mounted), reasonable wear and tear and loss by casualty or other causes beyond Licensee's control excepted.

20. **Notices.** Any notice, request, demand, statement, or consent herein required or permitted to be given by either party to the other hereunder, shall be in writing signed by or on behalf of the party giving the notice and addressed to the other at the address as set forth below:

<u>Licensee</u>	Cellco Partnership d/b/a Verizon Wireless 180 Washington Valley Road Bedminster, New Jersey 07921 Attention: Network Real Estate
-----------------	--

<u>Licensor</u>	City of Coeur d'Alene 710 E. Mullan Avenue Coeur d'Alene, ID 83814 Attention: City Clerk
-----------------	---

Each party may by notice in writing change its address for the purpose of this Agreement, which address shall thereafter be used in place of the former address. Each notice, demand, request, or communication which shall be mailed to any of the aforesaid shall be deemed sufficiently given, served, or sent for all purposes hereunder (i) two business days after it shall be mailed by United States registered or certified mail, postage prepaid and return receipt requested, in any post office, branch post office or mailbox regularly maintained by the United States Postal Service, (ii) upon personal delivery, or (iii) one business day after deposit with any recognized commercial air courier or express service. Any communication made by e-mail or similar method shall not constitute notice pursuant to this Agreement.

21. **Miscellaneous.**

21.1. Entire Agreement. This Agreement constitutes the entire agreement and understanding between the Parties regarding the subject matter hereof, and supersedes all prior negotiations, understandings or agreements. Any amendments to this Agreement must be in writing and executed by both Parties.

21.2. Severability. If any provision of this Agreement is deemed invalid or unenforceable by a court or agency of competent jurisdiction, the remainder of this Agreement shall not be affected and each such other provision of this Agreement shall be valid and enforceable to the fullest extent permitted by law.

21.3. Governing Law. This Agreement shall be governed by the laws of the State of Idaho without regard to choice of law rules.

21.4. Jurisdiction and Venue. In the event any court action is brought directly or indirectly by reason of this Agreement, the State District Court in Coeur d'Alene, Idaho shall have jurisdiction over the dispute and proper venue shall be in the City.

21.5. Change of Law. If any federal or state laws or regulations or any binding judicial interpretations thereof that govern any aspect of the rights or obligations of one or more parties under this Agreement shall change after the Execution Date and such change makes any aspect of such rights or obligations inconsistent with the then-effective federal or state laws, regulations or binding judicial interpretations, then the parties agree to promptly amend the Agreement as reasonably required to accommodate and/or ensure compliance with any such legal or regulatory change.

21.6. Exhibits. All Exhibits referred to and attached to this Agreement are incorporated herein by reference.

21.7. Authority to Execute. Any individual executing this Agreement on behalf of or as a representative for a corporation or other person, partnership or entity, represents and warrants that he or she is duly authorized to execute and deliver this Agreement on behalf of such party, and this Agreement is binding upon such party in accordance with its terms.

21.8. No Waiver. A Party shall not be excused from complying with any of the terms and conditions of this Agreement by any failure of the other Party upon any one or more occasions to insist upon or to seek compliance with any such terms or conditions.

21.9. Force Majeure. With respect to the violation of or non-compliance with any provision of this Agreement which could result in the imposition of a financial penalty, forfeiture or other sanction upon a Party, such violation or non-compliance shall be excused where such violation or non-compliance is the result of acts of God, war, civil disturbance, strike or other labor unrest, or other events, the occurrence of which was not reasonably foreseeable by such Party and is beyond such Party's reasonable control.

21.10. Limitation of Liability. Neither Party shall be liable to the other, or any of their respective agents, representatives or employees for any lost revenue, lost profits, loss of technology, punitive, special or consequential damages, loss of data, or interruption or loss of use of service, even if advised of the possibility of such damages, whether under theory of contract, tort (including negligence), strict liability or otherwise.

21.11. Cumulative Remedies. No provision in this Agreement made for the purpose of securing enforcement of the terms and conditions of this Agreement shall be deemed an exclusive remedy or to afford the exclusive procedure for the enforcement of said terms and conditions, but the remedies herein provided are deemed to be cumulative.

21.12. No Third-Party Beneficiary. It is not intended by any of the provisions of this Agreement to create for the public, or any member thereof, a third-party beneficiary right or remedy or to authorize anyone else to maintain a suit for personal injuries or property damage pursuant to the provisions of this Agreement.

21.13. Time is of the Essence. Time is of the essence with regard to the performance of all of Licensee's obligations under this Agreement.

21.14. Attorneys' Fees. Should any dispute arising out of this Agreement lead to litigation, the prevailing Party shall be entitled to recover its cost of suit including (without limitation) reasonable attorneys' fees and expenses.

21.15. Contacting Licensee. Licensee shall be available to Licensor, its officers, employees and agents twenty-four (24) hours a day, seven (7) days a week regarding problems or complaints resulting from the attachment, installation, operation, maintenance or removal of Equipment. Licensor, its officers, employees and agents may contact by telephone the Network Control Center operator at (800) 621-2622 regarding such problems or complaints.

21.16 No Partnership or Joint Venture. The relationship between Licensor and Licensee is at all times solely that of licensor and licensee, not that of partners or joint venturers.

[Signature page follows]

IN WITNESS WHEREOF, the parties have executed this Agreement as of this 21st day of January, 2020 (the “Execution Date”).

LICENSOR:

The City of Coeur d’Alene, Idaho

By: _____
Print Name: Steve Widmyer
Its: Mayor

LICENSEE:

Cellco Partnership
d/b/a VERIZON WIRELESS

By: _____
Print Name: _____
Its: _____

ATTEST:

Renata McLeod, City Clerk

APPROVED AS TO FORM:

Michael C. Gridley, City Attorney

EXHIBIT A

Form of Site Supplement

SITE SUPPLEMENT

This Site Supplement (“Site Supplement” or “Supplement”), made this ____ day of _____, 20__ between the City of Coeur d’Alene, with an address of _____, hereinafter designated “Licensor” and Cellco Partnership d/b/a Verizon Wireless, with its principal offices at 180 Washington Valley Road, Bedminster, New Jersey 07921, hereinafter designated “Licensee”:

1. Supplement. This is a Site Supplement as referenced in that certain Agreement for the Use of Licensor Property in Connection with the Operation of a Wireless Network, between Licensor and Licensee dated _____, 20__ (“Agreement”). All of the terms and conditions of the Agreement are incorporated hereby by reference and made a part hereof without the necessity of repeating or attaching the Agreement. In the event of a contradiction, modification or inconsistency between the terms of the Agreement and this Supplement as to the placement or installation of Licensee’s Equipment, the terms of this Supplement shall govern. Capitalized terms used in this Supplement shall have the same meaning described for them in the Agreement unless otherwise indicated herein.

2. Project Location. Licensee shall have the right to use the Municipal Facility for Equipment at the designated areas in the ROW as further described in Exhibit 1 attached hereto (the “Licensed Area”).

3. Equipment. The Equipment to be installed at the Licensed Area is described in Exhibit 1 attached hereto.

4. Term. The term of this Supplement shall be as set forth in Section 3.2 of the Agreement.

5. Fees. The initial Annual Fees for the term of this Supplement shall be _____, as determined in accordance with the Agreement as adjusted by Section 4.1 of the Agreement. The Application Fee paid upon submission of the request for this Supplement by Licensee is _____ and Licensee confirms the prior payment to Licensor of the Application Fee upon submittal of this Supplement.

6. Commencement Date. The first day of the month following the date Licensee has commenced installation of its Equipment at the Licensed Area.

7. Approvals/Fiber. It is understood and agreed that Licensee’s ability to use the Licensed Area is contingent upon its obtaining all of the certificates, permits and other approvals (collectively the “Governmental Approvals”) that may be required by any Federal, State or Local authorities, as well as a satisfactory fiber and electrical connection which will permit Licensee use of the Licensed Area as set forth above. In the event that (i) any of such applications for such Governmental Approvals should be finally rejected; (ii) any Governmental Approval issued to Licensee is canceled, expires, lapses, or is otherwise withdrawn or terminated by governmental authority; (iii) Licensee determines that such Governmental Approvals may not be obtained in a

timely manner; (iv) Licensee determines that it will be unable to obtain in a satisfactory manner, or maintain any fiber or power connection; or (v) Licensee determines that the Licensed Area is no longer technically compatible for its use, Licensee shall have the right to terminate this Supplement. Notice of Licensee's exercise of its right to terminate shall be given to Licensor in writing by certified mail, return receipt requested, and shall be effective upon the mailing of such notice by Licensee, or upon such later date as designated by Licensee. All rentals paid to said termination date shall be retained by Licensor. Upon such termination, this Supplement shall be of no further force or effect except to the extent of the representations, warranties and indemnities made by each party to the other hereunder or under the Agreement. Otherwise, Licensee shall have no further obligations for the payment of Rent to Licensor for this Supplement.

8. Miscellaneous._____.

[Signature page follows]

EXECUTED to be effective as of the date shown above.

LICENSOR:

By: _____

Name: _____

Title: _____

ATTEST:

_____, Clerk

APPROVED AS TO FORM

BY: _____
City Attorney

LICENSEE:

CELLCO PARTNERSHIP
D/B/A VERIZON WIRELESS

By: _____

Print Name: _____

Its: _____

Exhibits:
Exhibit 1

Exhibit 1

Licensed Area

EXHIBIT B

Licensee's Minimum Insurance Requirements

1. General.

A. Prior to performing work under this Agreement, Licensee shall furnish Licensor a certificate of insurance on a standard insurance industry ACORD form or its equivalent. The insurance coverage required must be issued by an insurer licensed, authorized or permitted to transact business in the State of Idaho, possessing a current A.M. Best, Inc. rating of A-VII or better, and coverage shall be reasonably satisfactory to Licensor.

B. Licensee shall require any of its contractors to obtain and maintain substantially the same coverage as required of Licensee, and procure and maintain such insurance, until all of their obligations have been discharged.

C. The insurance requirements set forth in no way limit the indemnity covenants contained in this Agreement.

D. Failure to demand evidence of full compliance with the insurance requirements in this Agreement or failure to identify any insurance deficiency will not relieve Licensee from, nor will it be considered a waiver of, its obligation to maintain the required insurance at all times during the performance of this Agreement.

2. Scope and Limits of Insurance. Licensee shall provide coverage with limits of liability not less than those stated below.

A. Commercial General Liability-Occurrence Form. Licensee must maintain Commercial General Liability insurance with a limit of \$2,000,000 per occurrence for bodily injury and property damage and \$4,000,000 general aggregate including premises-operations, products and completed operations, independent contractor, contractual liability, personal injury and advertising injury.

B. Commercial Automobile Liability. Licensee must maintain Commercial Automobile Liability insurance in the amount of \$1,000,000 combined single limit each accident for bodily injury and property damage covering all of Licensee's owned, hired, and/or non-owned vehicles assigned to or used in the performance of Licensee's work or activities under this Agreement.

C. Workers Compensation and Employers Liability Insurance. Licensee must maintain Workers Compensation insurance in compliance with the statutory requirements of the state of operation and Employer's Liability with a limit of \$1,000,000 for each accident; \$1,000,000 disease for each employee; and \$1,000,000 disease-policy limit.

D. Builders' Risk/Installation Floater Insurance. Builders' Risk/Installation Floater Insurance must be maintained until whichever of the following first occurs: (i) final payment has been made; or, (ii) until no person or entity other than Licensor, has an insurable interest in the property required to be covered.

(1) The Builders' Risk/Installation Floater insurance must be endorsed so that the insurance will not be canceled or lapse because of any partial use or occupancy by Licensor.

(2) The Builders' Risk/Installation Floater insurance must include as named insureds, Licensor, Licensee, and all tiers of contractors and others with an insurable interest in the work or project.

(3) The Licensee is responsible for payment of all deductibles under the Builders' Risk/Installation Floater insurance policy.

3. Additional Policy Requirements.

A. Miscellaneous Provisions.

(1) Licensee's insurance coverage must be primary insurance with respect to Licensor, its officers, officials, and employees. Any insurance or self-insurance maintained by Licensor, its officers, officials, and employees shall be in excess of the coverage provided by Licensee and must not contribute to it.

(2) Licensee's insurance must apply separately to each insured against whom a claim is made or suit is brought, except with respect to the limits of the insurer's liability.

(3) The policies must contain a severability of interest clause and waiver of subrogation against Licensor, its officers, officials, and employees, for losses arising from work performed by Licensee for Licensor.

(4) Licensee is required to maintain Commercial General Liability insurance as specified in this Agreement for a minimum period of one (1) year following completion and acceptance of the work. Licensee must submit a Certificate of Insurance evidencing Commercial General Liability insurance during this period evidencing the insurance requirement and, including the required Additional Insureds set forth herein.

(5) If a Certificate of Insurance is submitted as verification of coverage, Licensor will reasonably rely upon the Certificate of Insurance as evidence of coverage but this acceptance and reliance will not waive or alter in any way the insurance requirements or obligations of this Agreement.

(6) Upon receipt of notice from its insurer, Licensee shall use its best effort to provide the Licensor with thirty (30) days prior written notice of cancellation. Such notice shall be sent directly to _____.

B. Licensor as Additional Insured. The above-referenced policies shall, excluding workers compensation and employer's liability, include the Licensor, its officers, officials, and employees as additional insureds as their interests may appear under this Agreement with respect to liability and Losses arising out of activities performed by or omissions of Licensee.

PUBLIC HEARINGS

CITY COUNCIL STAFF REPORT

DATE: January 21, 2020
FROM: Dennis J. Grant, Engineering Project Manager
SUBJECT: **V-19-03, Vacation of a portion of Seltice Way right-of-way adjoining the southerly boundary of Tax No. 8882, Tax No. 10490, and Tax No. 22364 in the City of Coeur d'Alene.**

DECISION POINT

Should the City vacate the portion of right-of-way along the north side of Seltice Way, east of Atlas Road to the applicant (William L. Sheldon)?

HISTORY

The four (4) lane divided highway known as Seltice Way was originally constructed in 1926 as US Highway 10, with the portion from Coeur d'Alene to the Idaho/Washington boundary being replaced by I-90 in 1971. This portion of Seltice Way adjoining the area of request has a right-of-way of +/- 200 feet.

FINANCIAL ANALYSIS

The vacation of the requested right-of-way would not have any financial impact on the City and would add approximately .24 acres to the future County tax roll. It would be a benefit to the municipality as tax revenue and to the land owner whose lots adjoin the strip of usable property.

PERFORMANCE ANALYSIS

The purpose of this request is to vacate the unused portion of right-of-way along the north side of Seltice Way, east of Atlas Road. Seltice Way was recently reconstructed, widened and rebuilt. As part of this construction, a bike path was added along the north side of Seltice Way. The applicants are proposing to vacate a portion of Seltice Way, which is 2 feet north of the current trail/toe of slope as shown on the exhibit. The request would not have any impact on future expansion of the Seltice Way corridor since the current project is complete. The Development Review Team was informed about this vacation.

RECOMMENDATION

City Council should approve the vacation action per Idaho Code Section 50-1306 and to vacate the property to the applicant, William L. Sheldon.

I - 90

W Centennial Trl

2691

2621

2619

Proposed Vacation

W Seltice Way

Seltice Way

BASIS OF BEARINGS

THE SOUTH LINE OF SECTION 3 BEARS N89°11'14"W, AS SHOWN ON RECORD OF SURVEY AS RECORDED IN BOOK 23 OF SURVEYS, PAGE 452, RECORDS OF KOOTENAI COUNTY, IDAHO.

EXHIBIT NOTES

1. THE INTENT OF THIS EXHIBIT SHALL BE TO PORTRAY THE PROPOSED SELTICE WAY RIGHT OF WAY VACATION, FRONTING PARCEL C-000-003-7130.
2. THE PROPOSED SELTICE WAY RIGHT OF WAY VACATION SHALL BE TO APPROXIMATELY 2.0' NORTH OF THE EXISTING ASPHALT TRAIL EDGE, AND/OR 2.0' NORTH OF THE EXISTING TOP/TOE OF SLOPE CREATED DURING THE DEVELOPMENT OF THE EXISTING ASPHALT TRAIL AS SURVEYED BY OUR FIRM.
3. THERE WAS NO ATTEMPT TO SHOW ALL FEATURES OF THIS PROPERTY.
4. THIS EXHIBIT IS NOT A BOUNDARY SURVEY OF ANY KIND.
5. VERTICAL DATUM IS ASSUMED.

LEGEND

- △ = CALCULATED POINT (NOTHING FOUND OR SET)
- = FOUND 1/2" REBAR WITH PLASTIC CAP MARKED "PLS 5289" (UNLESS OTHERWISE NOTED)
- = FOUND ALUMINUM CAP AS NOTED
- = FOUND DRILL STEEL
- = BOUNDARY LINE
- - - = PROPOSED BOUNDARY LINE
- - - = SECTION LINE
- - - = EXISTING RIGHT-OF-WAY LINE
- - - = EXISTING CONTOURS
- 100 = EXISTING ASPHALT
- ▨ = PROPOSED RIGHT-OF-WAY VACATION

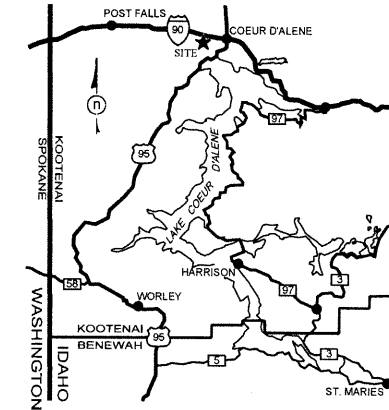

VICINITY MAP
NTS

PARCEL: C-0000-003-6940
OWNER: FAMILLE HOLDINGS LLC.

PARCEL: C-0000-003-7000
OWNER: KLSRMS LLC.

PARCEL: C-0000-003-6940
OWNER: FAMILLE HOLDINGS LLC.

PARCEL: C-000-003-7130
EXISTING: 66,035 SQ. FT. 1.516 ACRES
PROPOSED: 76,374 SQ. FT. 1.753 ACRES

EXISTING BUILDING

EXISTING PARKING LOT

RIGHT-OF-WAY VACATION
PROPOSED: 10,339 SQ. FT. 0.237 ACRES

SECTION CORNER
3" ALUMINUM CAP PER
C.P.&F 1259225

2650.36
N89°11'14"W
BASIS OF BEARINGS

QUARTER CORNER
2-1/4" ALUMINUM CAP
PER C.P.&F 1376710



0 20 40
scale in feet
1"=20' (22x34)
1"=40' (11x17)

EXHIBIT 'B'



SURVEYORS & ENGINEERS
7600 N. Mineral Dr., Ste. 900
Coeur d'Alene, Idaho 83815
Phone: (208) 772-6600
Fax: (208) 772-6619
www.h2survey.com

SURVEYED H2	DESIGNED H2	DRAWN EI	CHECKED SLM
-------------	-------------	----------	-------------



SELTICE WAY
RIGHT OF WAY VACATION
CITY OF COEUR D'ALENE, IDAHO

RIGHT-OF-WAY
EXHIBIT

SHEET #	X
PROJECT #	2019-004
DATE	09/09/19

COUNCIL BILL NO. 20-1000
ORDINANCE NO. _____

AN ORDINANCE OF THE CITY OF COEUR D'ALENE, VACATING A PORTION OF SELTICE WAY RIGHT-OF-WAY, GENERALLY DESCRIBED AS A PARCEL OF LAND ADJOINING THE SOUTHERLY BOUNDARY OF TAX NO. 8882, TAX NO. 10490, AND TAX NO. 22364 IN THE CITY OF COEUR D'ALENE, KOOTENAI COUNTY, IDAHO; REPEALING ALL ORDINANCES AND PARTS OF ORDINANCES IN CONFLICT HEREWITH; PROVIDING A SEVERABILITY CLAUSE; AND PROVIDING FOR THE PUBLICATION OF A SUMMARY OF THIS ORDINANCE AND AN EFFECTIVE DATE HEREOF.

WHEREAS, after public hearing, the City Council finds it to be in the best interests of the City of Coeur d'Alene and the citizens thereof that said portion of right-of-way be vacated; NOW, THEREFORE,

BE IT ORDAINED, by the Mayor and City Council of the City of Coeur d'Alene:

SECTION 1. That the following described property, to wit:

Legal description and drawing, attached as Exhibits "A & B"

be and the same is hereby vacated.

SECTION 2. That said vacated right-of-way shall revert to the adjoining property owners to the north.

SECTION 3. That the existing right-of-way, easements, and franchise rights of any lot owners, public utility, or the City of Coeur d'Alene shall not be impaired by this vacation, as provided by law, and that the adjoining property owners shall in no manner place any obstruction over any public utilities.

SECTION 4. All ordinances and parts of ordinances in conflict with this ordinance are hereby repealed.

SECTION 5. After its passage and adoption, a summary of this Ordinance, under the provisions of the Idaho Code, shall be published once in the official newspaper of the City of Coeur d'Alene, and upon such publication shall be in full force and effect.

Passed under suspension of rules upon which a roll call vote was duly taken and duly enacted an ordinance of the City of Coeur d' Alene at a regular session of the City Council on January 21, 2020.

APPROVED by the Mayor this 21st day of January, 2020.

Steve Widmyer, Mayor

ATTEST:

Renata McLeod, City Clerk

SUMMARY OF COEUR D'ALENE ORDINANCE NO. _____
V-19-03, SELTICE WAY RIGHT-OF-WAY VACATION

The City of Coeur d'Alene, Idaho hereby gives notice of the adoption of Coeur d'Alene Ordinance No. ____, vacating a portion of Seltice Way right-of-way.

Such right-of-way is more particularly described as follows:

Attached Exhibit's "A & B" are on file in the City Clerk's Office

The ordinance further provides that the ordinance shall be effective upon publication of this summary. The full text of the summarized Ordinance No. ____ is available at Coeur d'Alene City Hall, 710 E. Mullan Avenue, Coeur d'Alene, Idaho 83814 in the office of the City Clerk.

Renata McLeod, City Clerk

STATEMENT OF LEGAL ADVISOR

I, Randall R. Adams, am Chief Civil Deputy City Attorney for the City of Coeur d'Alene, Idaho. I have examined the attached summary of Coeur d'Alene Ordinance No. ____, V-19-03, Seltice Way right-of-way vacation and find it to be a true and complete summary of said ordinance which provides adequate notice to the public of the context thereof.

DATED this 21st day of January, 2020.

Randall R. Adams, Chief Civil Deputy City Attorney

EXHIBIT 'A'

Right-of-Way Vacation Legal Description

A parcel of land located in the Southeast Quarter of the Southwest Quarter of Section 3, Township 50 North, Range 4 West, Boise Meridian, City of Coeur d'Alene, Kootenai County, Idaho, more particularly described as follows:

Commencing at the southeast corner of Southwest Quarter of Section 3, Township 50 North, Range 4 West, Boise Meridian, Idaho, from which the southwest corner of the Southwest Quarter of said Section 3, bears North 89° 11'14" West, a distance of 2650.36 feet as shown on Record of Survey recorded in Book 23, Page 452, records of Kootenai County, Idaho;

thence North 00° 05'54" West, a distance of 25.87 feet to the **Point of Beginning**;

thence North 85° 15'43" West, a distance of 56.97 feet;

thence North 89° 34'28" West, a distance of 123.02 feet;

thence South 86° 42'25" West, a distance of 62.66 feet;

thence South 73° 01'44" West, a distance of 25.29 feet;

thence North 87° 16'49" West, a distance of 108.90 feet;

thence North 82° 32'34" West, a distance of 78.34 feet;

thence North 00° 49'27" East, a distance of 17.34 feet to the northerly right-of-way line of Seltice Way;

thence South 89° 26'55" East along said northerly right-of-way line of Seltice Way, a distance of 452.82 feet;

thence South 00° 08'50" West leaving said northerly right-of-way line of Seltice Way, a distance of 22.95 feet to the **Point of Beginning**;

Containing 10,339 square feet or 0.237 acres, more or less.

SUBJECT TO:

Existing rights-of-way and easements of record and or appearing on said above described parcels.

END OF DESCRIPTION

Prepared by this office:
h2 Surveying, LLC



JTB 1/15/19

BASIS OF BEARINGS

THE SOUTH LINE OF SECTION 3 BEARS N89°11'14"W, AS SHOWN ON RECORD OF SURVEY AS RECORDED IN BOOK 23 OF SURVEYS, PAGE 452, RECORDS OF KOOTENAI COUNTY, IDAHO.

EXHIBIT NOTES

1. THE INTENT OF THIS EXHIBIT SHALL BE TO PORTRAY THE PROPOSED SELTICE WAY RIGHT OF WAY VACATION, FRONTING PARCEL C-000-003-7130.
2. THE PROPOSED SELTICE WAY RIGHT OF WAY VACATION SHALL BE TO APPROXIMATELY 2.0' NORTH OF THE EXISTING ASPHALT TRAIL EDGE, AND/OR 2.0' NORTH OF THE EXISTING TOP/TOE OF SLOPE CREATED DURING THE DEVELOPMENT OF THE EXISTING ASPHALT TRAIL AS SURVEYED BY OUR FIRM.
3. THERE WAS NO ATTEMPT TO SHOW ALL FEATURES OF THIS PROPERTY.
4. THIS EXHIBIT IS NOT A BOUNDARY SURVEY OF ANY KIND.
5. VERTICAL DATUM IS ASSUMED.

LEGEND

- △ = CALCULATED POINT (NOTHING FOUND OR SET)
- = FOUND 1/2" REBAR WITH PLASTIC CAP MARKED "PLS 5289" (UNLESS OTHERWISE NOTED)
- = FOUND ALUMINUM CAP AS NOTED
- = FOUND DRILL STEEL
- = BOUNDARY LINE
- - - = PROPOSED BOUNDARY LINE
- - - = SECTION LINE
- - - = EXISTING RIGHT-OF-WAY LINE
- - - = EXISTING CONTOURS
- 100 = EXISTING ASPHALT
- ▨ = PROPOSED RIGHT-OF-WAY VACATION

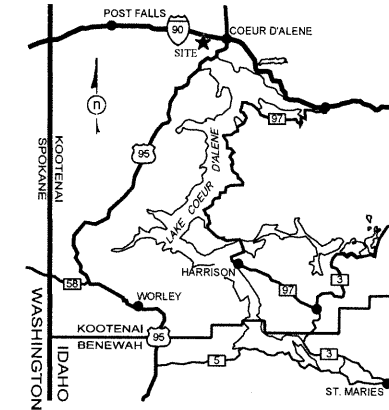

VICINITY MAP
NTS

PARCEL: C-0000-003-6940
OWNER: FAMILLE HOLDINGS LLC.

PARCEL: C-0000-003-7000
OWNER: KLSRMS LLC.

PARCEL: C-0000-003-6940
OWNER: FAMILLE HOLDINGS LLC.

PARCEL: C-000-003-7130
EXISTING: 66,035 SQ. FT. 1.516 ACRES
PROPOSED: 76,374 SQ. FT. 1.753 ACRES

EXISTING BUILDING

EXISTING PARKING LOT

RIGHT-OF-WAY VACATION
PROPOSED: 10,339 SQ. FT. 0.237 ACRES

SECTION CORNER
3" ALUMINUM CAP PER
C.P.&F 1259225

2650.36
N89°11'14"W
BASIS OF BEARINGS

QUARTER CORNER
2-1/4" ALUMINUM CAP
PER C.P.&F 1376710



0 20 40
scale in feet
1"=20' (22x34)
1"=40' (11x17)

EXHIBIT 'B'

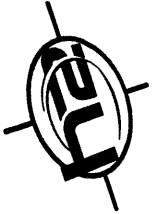

SURVEYORS & ENGINEERS
7600 N. Mineral Dr., Ste. 900
Coeur d'Alene, Idaho 83815
Phone: (208) 772-6600
Fax: (208) 772-6619
www.h2survey.com

SURVEYED H2	DESIGNED H2	DRAWN EI	CHECKED SLM
-------------	-------------	----------	-------------



SELTICE WAY
RIGHT OF WAY VACATION
CITY OF COEUR D'ALENE, IDAHO

RIGHT-OF-WAY
EXHIBIT

SHEET #	X
PROJECT #	2019-004
DATE	09/09/19